

## GENERAL INFORMATION

### 1.1 SCOPE OF MANUAL

This manual contains operating and maintenance information for the Divider Module (ADB), manufactured by MOORE INDUSTRIES INC., Sepulveda, California. The manual consists of six sections as follows:

*Section 1, General Information,* introduces the equipment function and describes the equipment physical appearance, the equipment specifications, and options available for the unit. The introduction also provides information on the use and description of the MOORE model numbering system.

*Section 2, Calibration,* provides all the information necessary to calibrate the unit before installation. This section contains a list of the tools necessary for calibrating the equipment; and illustrates the test setups essential to perform that task. The section also lists the various procedures required for calibration of the units in any configuration.

*Section 3, Installation and Operation,* supplies all the information needed to install and operate the equipment. The section contains figures that specify the installation requirements for the units, and text that informs the user on recommended wiring practices for the equipment as well as defines the electrical connections for each unit regardless of physical modifications. A brief outline of periodic observations required during the equipment operation is also included here.

*Section 4, Theory of Operation,* gives the maintenance personnel a detailed explanation of the internal function of the unit. The circuit theory is based on a block diagram that shows the functional elements of the unit. Each element operation is then described, first in relation to the other element, then independently where its major components' use and purpose are described.

*Section 5, Maintenance,* offers complete disassembly procedures for all unit configurations available. Troubleshooting information is also provided in this section as well as component replacement techniques to aid the technician in the repair of the equipment.

*Section 6, Unit Documentation,* acquaints the user with the MOORE IND. computerized parts listing and identification system. The section also provides a recommended spare parts list. All schematics and parts assembly drawings referred to by the text are located in the back of Section 6.

### 1.2 EQUIPMENT DESCRIPTION

The Divider Module (ADB) is used in process control systems to perform the computation:

$$\% \text{ Output} = \%A_{\text{Input}} \div \%B_{\text{Input}}$$

One process input percentage (A) is divided by the other (B) to provide a current or voltage output as the quotient. Applications of this module include processes in which mass flow, true watts, BTU, or any other quantity in which a quotient is involved must be computed.

### 1.3 PHYSICAL DESCRIPTION

The ADB is available in several different physical configurations. In general, the unit consists of two circuit boards, with one small board mounted on a main board. The small board contains voltage regulators and a rectifier, and the main board contains all the signal-processing and signal-generating circuits.

The boards are enclosed in a protective housing, and the entire assembly may be installed in a number of ways. Specific details about each unit is outlined in this section, while the following paragraphs outline the physical differences of each option available for the units. Electrical connections information are given in Section 3, Installation and Operation.



*Standard (STD) Unit*

#### 1.3.1 Conduit Plate Option (CP) Description

This option consists of an extension of the standard bracket lower mounting flange. The additional surface is cut with two mounting holes to accommodate  $\frac{1}{2}$ -inch electrical conduit. This option is illustrated in the next section outline and dimension drawings.

#### 1.3.2 Angle Bracket (AB) Option Description

This option consists of two angle brackets, one on the top and the other on the bottom of the unit.

These brackets are used to mount the unit in applications where the standard U-bracket will not apply. The brackets are provided with two #10 screw clearance holes each, for ease of mounting.



*Unit with Angle Bracket (AB) Option*

#### 1.3.3 NEMA Boxes Options Description

Units may be enclosed in NEMA boxes to ensure protection against harsh environments that may be damaging to the unit. Four configurations are available for this purpose.

*Oil Tight (OT) NEMA Box Option.* This enclosure consists of a NEMA12 box construction, with two cover-holding screw clamps, mounted opposite to the hinged side of the cover (right side). These enclosures are oil and dust tight only. Conduit holes, fittings, or knockouts are not provided on these boxes. Suggested fittings are "Myer's Scrutite." The units are mounted on a mounting plate at the back of the box with screws through the rear of the mounting plate.

*Water Tight (WT) NEMA Box Option.* This enclosure consists of a NEMA4 box construction equipped with three cover-holding screw clamps, one on each of the three non-hinged sides of the box. These enclosures are watertight, in addition to oil and dust tight. Unit mounting and electrical connections are made in the same manner as the OT option enclosures.



*Unit in Water Tight (WT) Enclosure*



*Corrosion Resistant Fiber Glass (FG) Enclosure*

**Fiber Glass (FG) Option Enclosures. (NEMA 4, 4X and 13)** This enclosure is molded from pigmented polyester resins, using 302 stainless steel for all exposed hardware. A one-piece neoprene jacket provides additional sealing protection against corrosive environments. Boxes are normally hinged on the long side. The cover is secured by four slot-head screws accessible at the top of the cover and located on each side of the top and bottom cover corners opposite the hinge side. Conduit holes may be cut with a hole punch, and special precautions must be taken with ground connections, since the box material is non-conductive. Refer to Section 3 for wiring information. Units are mounted into the enclosure in the same way as in the OT enclosures.

**General Purpose (GP) Options Enclosures.** This enclosure consists of a general purpose NEMA 1 steel construction box with knock-outs for various size electrical conduits ( $\frac{1}{2}$ ,  $\frac{3}{4}$ , or 1 inch). The cover is hinged and spring locked. Units are equipped with angle brackets (AB) option and secured into the enclosure on four studs and four 6-32 nuts. The complete enclosure can be secured through four mounting holes provided on the box back cover.



*General Purpose (GP) Enclosure*

### 1.3.4 RAA and RAT Options Description

These options consist of special mounting hardware attached to MOORE units to replace obsolete instrumentation of other manufacture.



*Replacement Mounting (RAA) Option*



*Replacement Mounting (RAT) Option*

### 1.3.5 Plug-In (PC) Units Description

The plug-in unit is electrically similar to the standard unit except that the unit consists of two board assemblies. One main board on which the power supply and most of the components are mounted and a small piggy-back board (PC2).

The printed circuit board is keyed to identify the unit and ensure proper connection mating. The other end of the main board is fastened to a display panel that allows external access to the various controls for the unit. A removable plastic safety cover protects the printed circuit board and components from normal environmental hazards. When the PC unit is purchased alone, the user must provide a 15 pin connector, such as Viking part No. ZVK155/1-2 or equivalent. Several mounting options are available for the plug-in unit.



*Plug-In (PC) Unit*

**Rack Mounted (RMR) Card Racks.** These enclosures are designed to flush-mount in standard 19 and 24-inch relay racks, respectively. The enclosures are provided with standard EIA hole patterns. Eleven and fifteen position RMR racks are available. These are pre-wired from the module PC connector to the screw-type barrier strip, which are rear-accessed for rack-wiring convenience. All power connections from the PC connectors are bussed together to a separate 3 terminal barrier-strip for external power input. DC power supplies are available. Electrical connections to the card rack are detailed in Section 3, Installation and Operation. Modules are front loaded and a dust cover is provided to minimize the

effects of environmental hazards. Module connectors are keyed to assure that units are plugged into their proper position, keying, however, may be altered in the field if the system configuration changes. Filler cards are available for positions not used by a module.

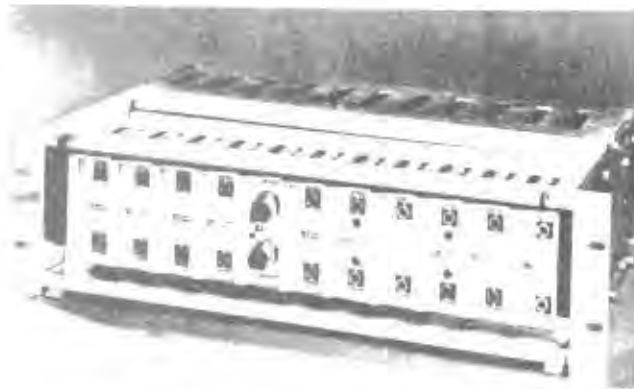

*Card Rack Enclosure for Relay Racks (RMR)*

**Surface Mounted (SMR) Card Rack.** These rack enclosures are designed to accommodate as few as five and up to 15 modules. Mounting flanges are located in the rear of the side panel which allows for surface mounting or for NEMA box mounting. These enclosures are electrically identical in construction to the RMR racks. Terminal strips for external connections, however, are front-accessed for wiring convenience whenever the rack is mounted into a NEMA box or against a wall.

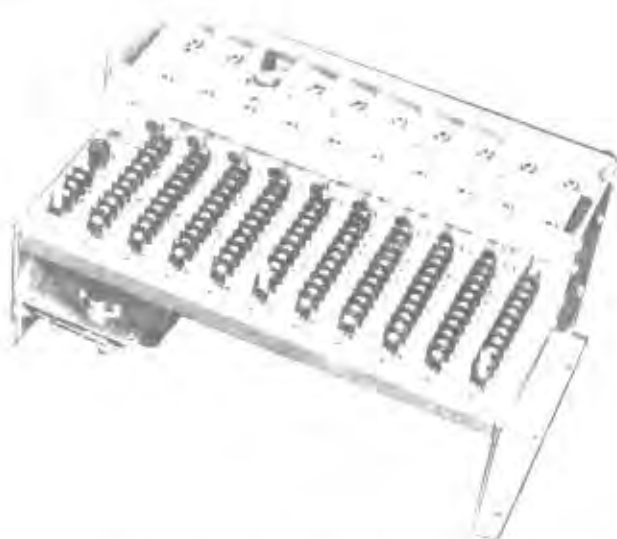

*Surface Mounted Card Racks (SMR)*

### 1.3.6 Standard Plug-In Transmitter (PST) Option

The standard plug-in transmitter consists of a terminal-strip-equipped enclosure as described in paragraph 1.3 except that connections are not provided on the face of the unit. Instead, the transmitter is attached physically and electrically to a circular interconnect card with plug-in pins, keyed to eliminate errors in connections. The mating connector consists of a bracket-mounted square terminal block. External electrical connections are made to screw terminals located on the periphery of the connector block. A plug-in receptacle arrangement is located in the center of the block to accommodate the keyed interconnect card plug-in pins from the transmitter. The mounting bracket secured to the terminal block is pre-drilled with clearance holes for 10-32 screws. When the transmitter assembly is removed, the terminal block screw connections are easily accessible.



*Plug-In Standard Unit (PST)*

### 1.3.7 Explosion Proof (EX, EXT, EXX) Option

The explosion-proof enclosure option consists of a PST option unit described in paragraph 1.3.6 enclosed into a two-piece cast aluminum alloy enclosure. The two pieces consist of a screw-type

cover and a connector housing. When the cover is removed, the PST type unit is easily accessible. With the PST unit unplugged, the terminal block is clearly visible and connections are made with ease. No mounting bracket is used on the terminal block as with the PST option. Instead, the terminal block is secured flush with the bottom of the housing. Electrical conduit hubs are provided for external electrical wiring through electrical conduits. Several configurations of conduit inputs are available. Refer to Section 3 for detailed description of conduit configurations.



*Explosion Proof Housing (EX Shown Only)*

### 1.3.8 Panel Mounted Transmitter (PM) Option

This option is electrically similar to the standard unit of paragraph 1.3, except that the enclosure and terminals locations are different. Instead of the standard enclosure, the printed circuit boards are enclosed in a metal frame equipped with a blank panel. Controls and electrical connections are accessible to the rear of the enclosure by removing a cover. The bottom of the frame is provided with two holes to accommodate 1/2-inch electrical conduit.

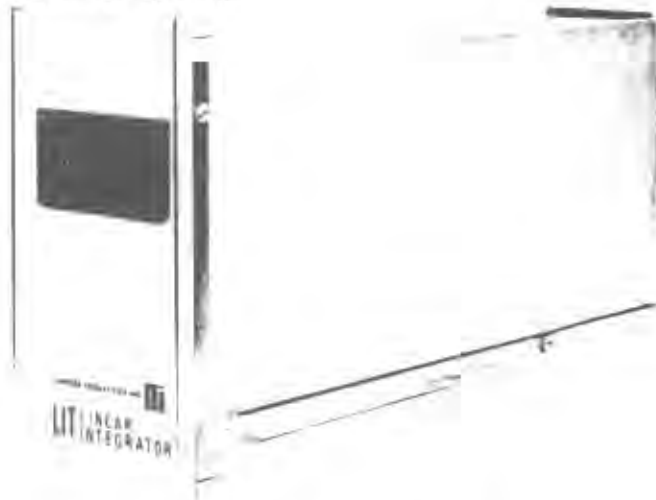

*Panel Mounted Unit (PM)*

## 1.4 SPECIFICATIONS

The specifications for the unit are listed in Table 1-1.

## 1.5 MODEL NUMBER EXPLANATION AND USE

MOORE INDUSTRIES' model numbers describe an instrument's type, functional characteristics, operating parameter, and include option identification. If all accompanying documentation of a unit is missing, the model number may be used to obtain technical information on the unit by following the example of Table 1-2. The model number for standard units, and units with CP and AB options, is located at the upper end of the terminal block stamped on a stainless steel tag. Plug-in units have their model number labeled on the inside of the grip extension to the front panel. PST units have the model number on top of the transmitter case. For explosion-proof units, the model number is stamped on a stainless steel tag on top of the enclosure and on the identification label on the unit within the enclosure. PM units model numbers are stamped on a stainless steel tag, visible when the rear safety cover is removed. To expose the model number on all NEMA box enclosures, open box and remove safety cover of the unit.

## 1.6 SERIAL NUMBER USE AND LOCATION

A complete history is kept on every MOORE unit. This information is keyed to the serial number. Whenever service data is required on a unit, it is necessary to provide the factory with a serial number as well as a model number. This identification is usually located with the model number (see paragraph 1.5 for location on equipment) except for plug-in units and explosion proof where the serial number is engraved into the PC board or stamped on a stainless steel tag respectively, and is usually preceded by the letter E.

**TABLE 1-1. UNIT SPECIFICATIONS**

**INPUT:**

**Current:**

- 1-5 mA into 200 ohms nominal
- 4-20 mA into 50 ohms nominal
- 10-50 mA into 20 ohms nominal

**Voltage:**

- 0-5V, 1-5V standard
- 10 megohms minimum input impedance
- Other voltages available

**FRONT PANEL ADJUSTMENTS:** Adjustable with multi-turn potentiometer

**Span:** With full scale input, adjusts output to 100%  $\pm 20\%$  of selected output span

**Zero:** With minimum input, adjusts output to 0%  $\pm 10\%$  of selected output span

**A & B Input Zero:** Compensates for input live zero offset for specified zero percent input  $\pm 10\%$  of span

**OUTPUT:** Operational amplifier feedback current source; output limited to 150% of maximum output range value

**Current:**

- 1-5 mA into 0-4800 ohm load
- 4-20 mA into 0-1200 ohm load
- 10-50 mA into 0-480 ohm load

**Voltage:** 1-5V DC standard into 20K ohms minimum

**Ripple:** Less than 0.25% of maximum signal (10 mV maximum P/P for a 5V signal)

**Load Effect:**  $\pm 0.01\%$  of span from 0 to maximum load resistance current output

**PERFORMANCE:**

**Calibration Capability:**  $\pm 0.25\%$  of span

**Ambient Temperature:**

Range:  $-20^{\circ}\text{F}$  to  $+180^{\circ}\text{F}$  ( $-29^{\circ}\text{C}$  to  $+82^{\circ}\text{C}$ )

Effect:  $\pm 0.01\%/^{\circ}\text{F}$  over above range

**Frequency Response:** 50 Hz (3-dB point)

**Isolation:** Voltage output units have input negative side common to output negative side. Current output models have output negative side elevated above input negative side. Mixed outputs are optionally available. Power input isolation is maintained on both AC and DC powered units.

**POWER INPUT:**

24V DC, 45V DC,  $\pm 10\%$

117V AC, 220V AC, or 240V AC, 50/60 Hz,  $\pm 10\%$

5 Watts nominal

**Line Voltage Effect:** AC or DC:  $\pm 0.005\%/1\%$  line change

**CERTIFICATION:** Canadian Standards Association

**ISA COMPLIANCE:** ISA S50.1, Section 5

**WEIGHT:** Approximately 2 lbs. (908 grams)

**TABLE 1-2. MODEL NUMBER EXAMPLES**

**ADB/2X4-20MA/1-5V/117AC/-TX [STD]**



**a. Similar Inputs**

Alternate example:

**ADB/A4-20MA B1-5V/1-5V/117AC/-TX [STD]**



**b. Dissimilar Inputs**



TABLE 1-3. ADB ELECTRICAL OPTIONS

OPTION DESCRIPTION	CODE
Power fuse on plug-in transmitter card (PC housing), 400 mA rating	FU
High-current voltage (20 mA) 1-5V DC output	HI
Internal "K" factor for the A input, factory set	KA
Internal "K" factor for the B input, factory set	KB
Internal "K" factor for the output, factory set	KO
RFI Filter Terminal Assembly — adds Moore Industries patented integral filter terminal assembly which prevents radio frequency energy from entering standard aluminum case	RF
Reverse Output	RO
Selectable Output or Input Current	SC
Two-wire Transmitter Excitation — 30V DC @ 25 mA output to a two-wire field transmitter. One 4-20 mA transmitter only. (See ESI-9)	TX

## CALIBRATION

### 2.1 GENERAL INFORMATION

This section provides information about unit calibration. Units with standard input and output levels are normally calibrated at the factory. After the unit is unpacked, general operating level checks of units is recommended. Usually these checks, specified in this section under calibration procedures, require little or no adjustments. If units are ordered with factory calibration option (FC), an exact calibration is performed at the factory, and red caps are placed on the controls. Adjustments should not be made in the field on these units unless a new range of input or output signal level is desired. Red caps should not be removed as a precaution against accidental adjustments.

### 2.2 CONTROLS DESCRIPTION AND LOCATION

The controls consist of ZERO and SPAN adjustments, located on the unit front panel. External controls are multiturn potentiometers that are adjusted with a blade screwdriver.

### CAUTION

**SCREWDRIVER BLADE MUST NOT BE MORE THAN 0.1 INCH (2.54 mm) WIDE. USE OF A WIDER BLADE MAY PERMANENTLY DAMAGE THE POTENTIOMETER MOUNTING.**

This type of potentiometer usually requires 20 turns of the shaft to move the wiper from one end of its range to the other. It is equipped with a slip clutch at either end of its travel to prevent damage if it is turned beyond the wiper stop. Usually a slight change in feel will be noticed when the clutch is slipping. However, if this change is not observed, either end can be reached by turning the shaft 20 turns in the desired direction. Controls are connected, so turning the shaft clockwise increases the quantity or makes it more positive, and turning the shaft counterclockwise has the opposite effect.

### 2.3 TEST EQUIPMENT AND TOOLS REQUIRED

Test equipment and tools required for calibration of the unit are described in Table 2-1; they are not

**TABLE 2-1. TEST EQUIPMENT AND TOOLS REQUIRED**

Equipment or Tool	Characteristic	Purpose
Screwdriver (blade)	Blade not wider than 0.1 inch (2.54 mm)	Front panel control adjustment
Adjustable Voltage or Current Source	Must be capable of producing signal ranges defined by INPUT level requirements of purchased unit (see Table 1-1)	Simulate input signal levels
DC Voltmeter	Must be accurate to within $\pm 0.05\%$ or better	Input signal monitoring (voltage inputs only). Output signal monitoring (voltage outputs only)
DC Milliammeter	Must be accurate to within $\pm 0.05\%$ or better	Input signal monitoring (current inputs only). Output signal monitoring (current outputs only)

supplied and must be provided by the customer at the installation or test site.

## 2.4 TEST EQUIPMENT SETUPS

Off-line calibration for all units require the same test equipment setups regardless of option or physical configuration. The hookup requirements and physical preparations may vary on some units. The following paragraphs define the general test setup and identify the units that require special attention for test preparation and connections.

### 2.4.1 General Test Equipment Setups

The test equipment setup required for calibration of all units is identical except for connection identification. Figure 2-1 shows the general test setup configuration. Connection nomenclature refer to terminal markings on the standard units with CP, AB, AA/TA, PM, and NEMA boxes mechanical options.

### 2.4.2 Plug-In Units Test Equipment Setup

Plug-in units equipment test setup is the same as the one shown in Figure 2-1, except that printed circuit board connections are identified in that figure by numbers in parentheses. Connection identification numbers are etched in the component side of the PC board. Plug-in unit: inserted in

a rack also use the test setup shown in Figure 2-1 with card rack terminal connections identified by numbers in parentheses. These include either the rack mount (RMR) or the surface mounted (SMR).

### 2.4.3 Explosion-Proof (EX) and PT or PST Option Test Setup

Figure 2-2 shows the general test setup configuration for an explosion-proof enclosure, PT, or PST option. Note that in the explosion proof configuration the protective housing must be opened and the unit removed to expose the connection block. Similarly, units with the PT or PST configuration must be unplugged from the connection block in order to access the connections more effectively. Numbers in parentheses refer to terminal block numbers.

## 2.5 CALIBRATION

Units are calibrated and checked for proper performance at the factory before they are shipped. However, unless calibration was requested to a specific set of input-output values, the unit performance should be checked by the user before the unit is placed in service. Calibration consists of simulating the operative signal input and adjusting the unit to obtain the specified output.

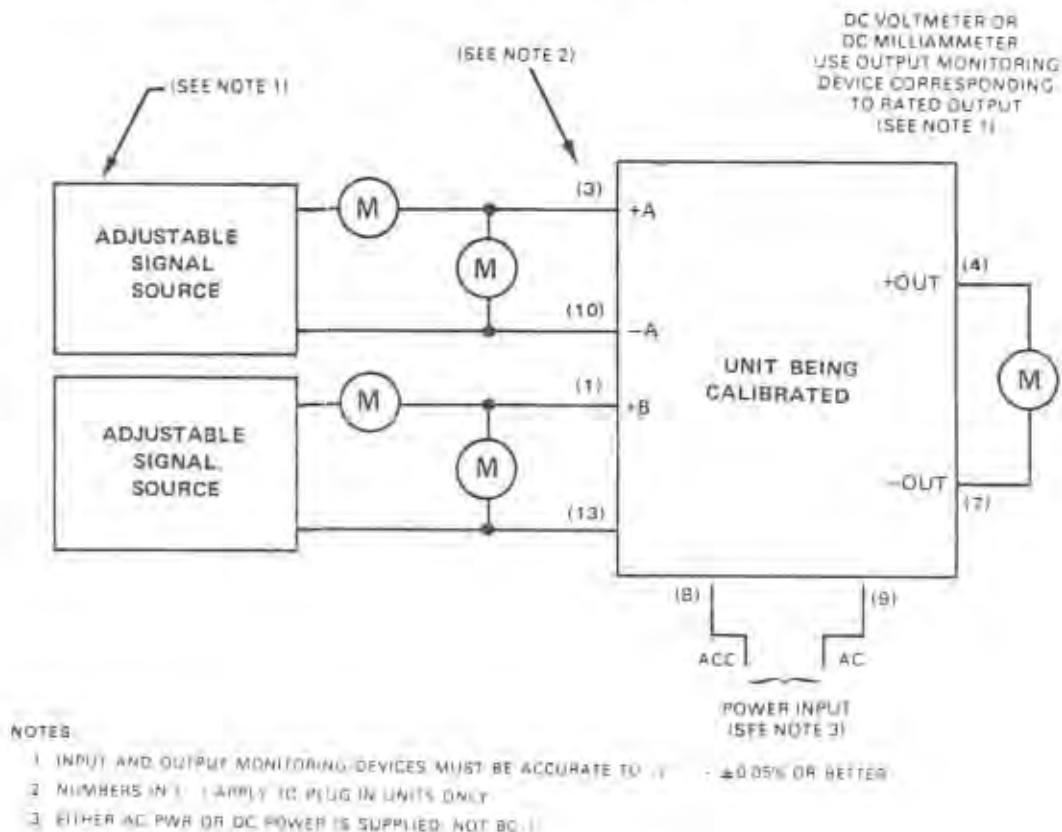

Figure 2-1. Test Equipment Setup For Calibration of Unit

## NOTE

Adjustments should *not* be made in the field on units that are calibrated to values specified in the purchase order. Units that are calibrated at the factory to customer's specifications have protective caps over the SPAN and ZERO potentiometers; do NOT remove these caps.

Two adjustable input signal sources and input monitoring devices and an output monitoring device are required for calibration. The monitoring devices (current or voltage) must have an accuracy within  $\pm 0.05\%$  or better. To calibrate a unit, proceed as follows:

- a. Refer to paragraph 5.2, Section 5 and remove the cover of the unit to gain access to the A and B INPUT ZERO potentiometers.

- b. Connect unit and test equipment as shown in Figure 2-1 or 2-2.
- c. Apply power input to the unit.

## NOTE

Refer to paragraph 1.5 for information on how to use the model number to obtain the specified values of minimum and maximum inputs and outputs.

- d. Adjust input signal source A to the maximum A input value specified for the unit (5 mA, 20 mA, 50 mA, 5V DC, or whatever the specified maximum A input is for the unit). Adjust input signal source B to 100% of the span.

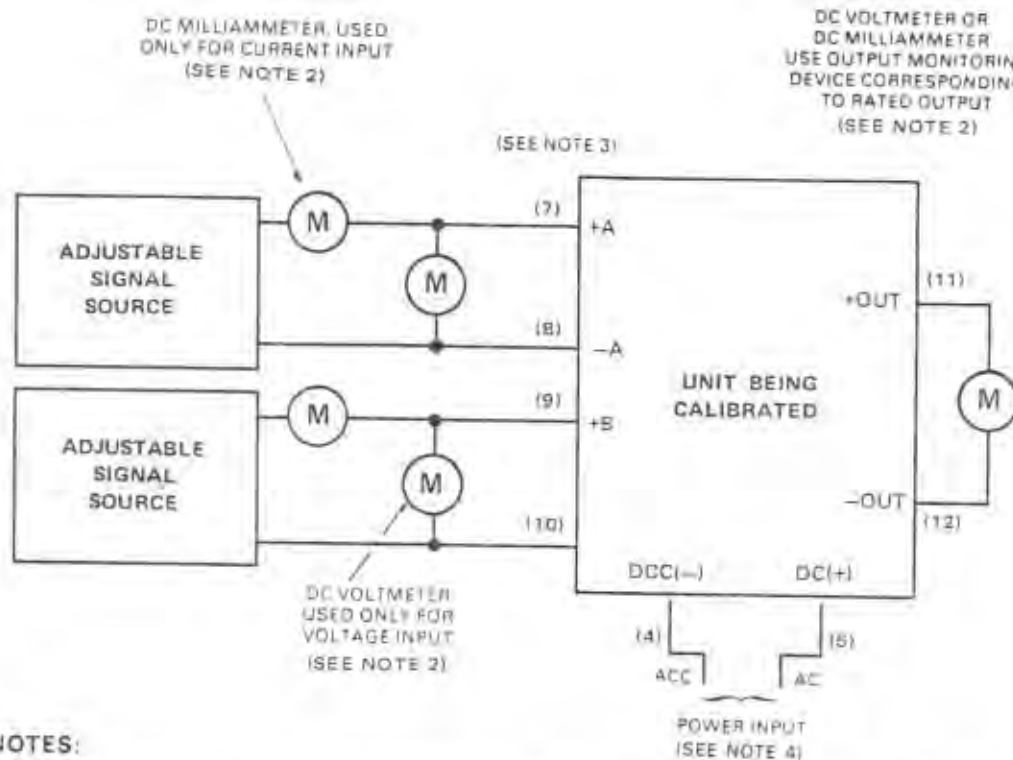

## NOTES:

1. Test setup must be locally fabricated. Components not supplied as a part of the purchased unit.
2. Input and output monitoring devices must be accurate to within  $\pm 0.05\%$  or better.
3. Numbers in ( ) refer to terminal block connector (see Figure 3-12).
4. Either AC power or DC power is supplied, but not both.
5. Calibration resistor terminals used for RC option only.

Figure 2-2. Test Equipment Setup For Calibration of Explosion Proof and PT or PST Unit.

- e. Adjust the SPAN potentiometer to obtain 100% output from the unit (5 mA, 20 mA, 50 mA, 5V DC, or whatever the specified 100% output is for the unit).
- f. Adjust input signal source A to the minimum A input specified for the unit (1 mA, 4 mA, 10 mA, 1V DC, or whatever the specified minimum A input is for the unit).
- g. Adjust the ZERO potentiometer to obtain 0% output from the unit.
- h. Repeat steps (d) through (g) as required until no further adjustment of either the SPAN or ZERO potentiometer is necessary.
- i. With input signal source A adjusted to the minimum value specified for the A input of the unit, vary input signal source B from approximately 1% of the span above the minimum value specified for the B input to the maximum value specified for that input of the unit.
- j. If necessary, adjust the A INPUT ZERO potentiometer so the output does not change when step (i) is repeated.
- k. Adjust input signal source B to 100% of the span above the minimum value specified for the B input on the unit. Vary input signal source A from the maximum input to 50% of the span above the minimum input specified for the A input of the unit.
- l. If necessary, adjust the B INPUT ZERO potentiometer so the specified change in output occurs when step (k) is repeated.
- m. Repeat steps (d) through (h) and (i) through (l) as required until the specified results are obtained and no further adjustment of the SPAN, ZERO, or A or B INPUT ZERO potentiometers is necessary.
- n. After step (m) has been successfully completed, remove the input signal sources, turn off the power input to the unit, and reinstall the cover on the unit.

# INSTALLATION AND OPERATION

## 3.1 MECHANICAL INSTALLATION

Units may be obtained in various physical configurations. Figures 3-1 through 3-10 show the outline dimensions and other installation requirements for the available configurations. Select the proper outline and dimension figure applicable to the unit purchased. Be sure to observe the applicable special procedures and precautions given with the illustration. Although the units are designed to operate in free air at quite a high ambient temperature, it is advisable, if possible, to mount the unit on a surface made of material that can serve as a heat sink. For a plug-in unit mounted in a rack, be sure that the rack has adequate ventilation.

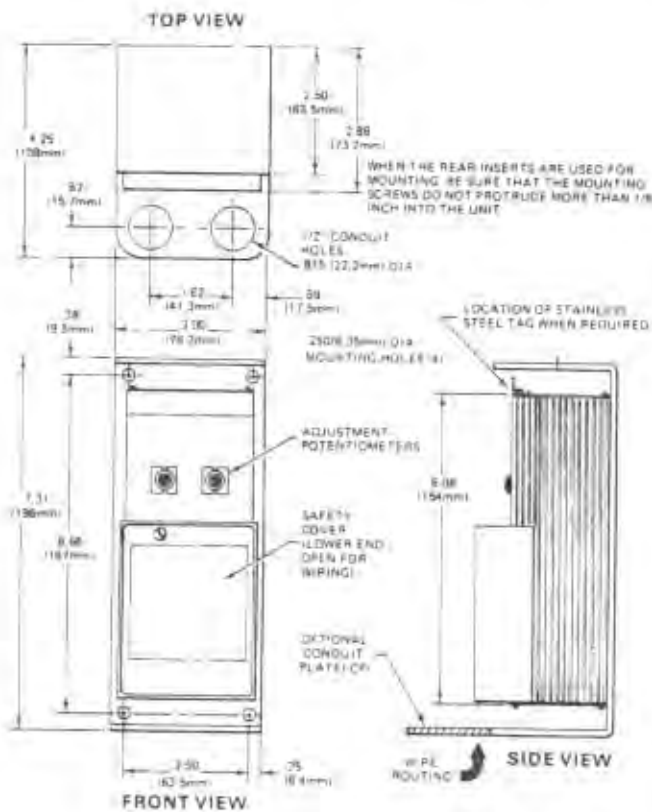

### NOTES

1. Complete Model No. and Serial No. are permanently marked on identification plate located at upper end of terminal blocks.
2. When extra-compact mounting is required for rack or portable installation, C-shaped mounting bracket may be removed and two threaded inserts (located 4.00 inches apart) may be used for mounting, using B-32NC machine screws.

**Figure 3-1. Standard Unit and Unit with CP Option. Outline and Dimensions**

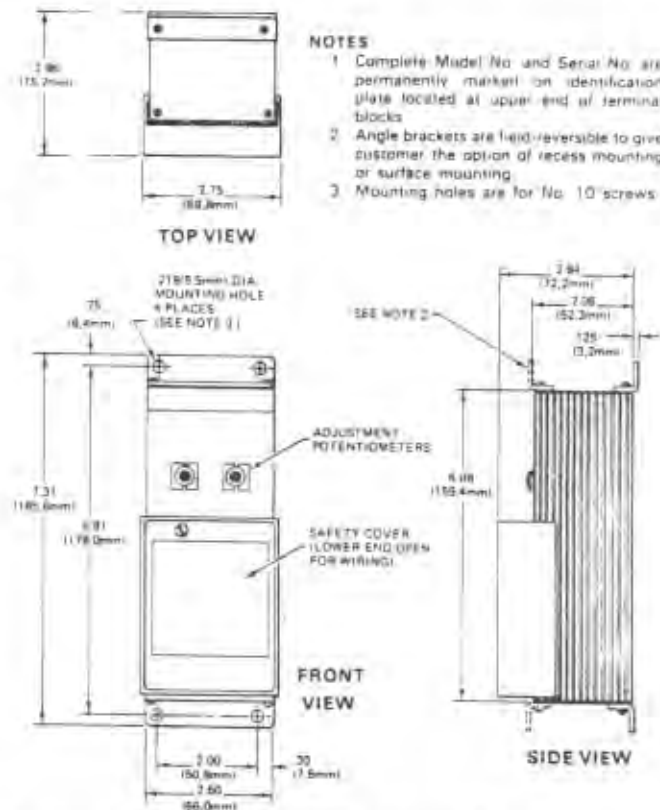

### NOTES

1. Complete Model No. and Serial No. are permanently marked on identification plate located at upper end of terminal blocks.
2. Angle brackets are field-reversible to give customer the option of recess mounting or surface mounting.
3. Mounting holes are for No. 10 screws.

**Figure 3-2. Standard Unit With Angle Brackets (AB) Option. Outline and Dimensions**

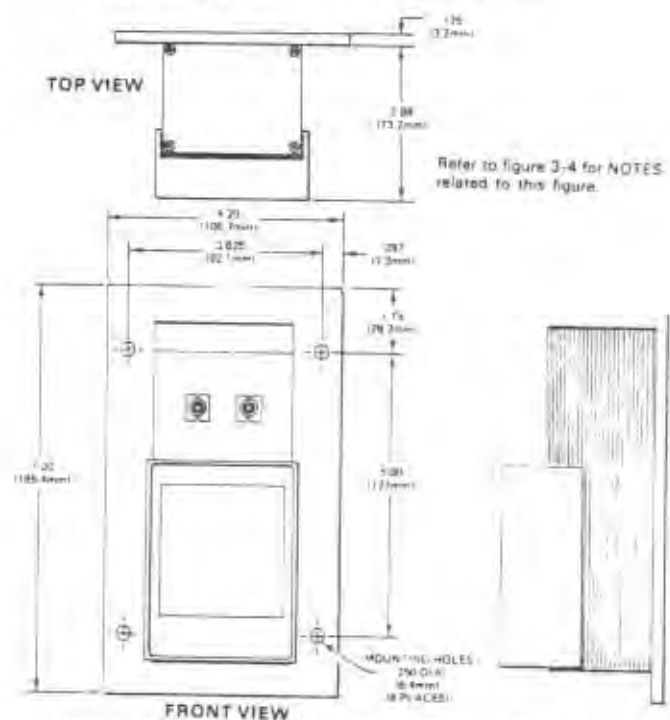

**Figure 3-3. Standard Unit With Adaptor Plate (RAA) Option. Outline and Dimensions**

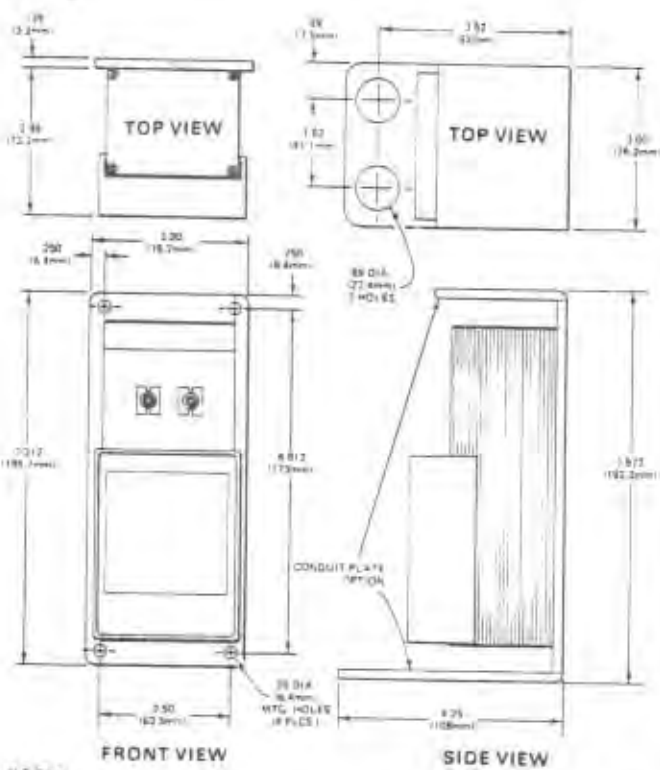

**NOTES:**

1. Use two threaded inserts (located 4.00 inches apart on back of standard transmitter) for mounting adapter plate to transmitter. Use 6-32 NC machine screws.
2. Unit to adapter plate mounting screws should not protrude more than 1/8" into the unit.

**Figure 3-4. Standard Unit, With Adapter Plate (RAT) Option, Outline and Dimensions**

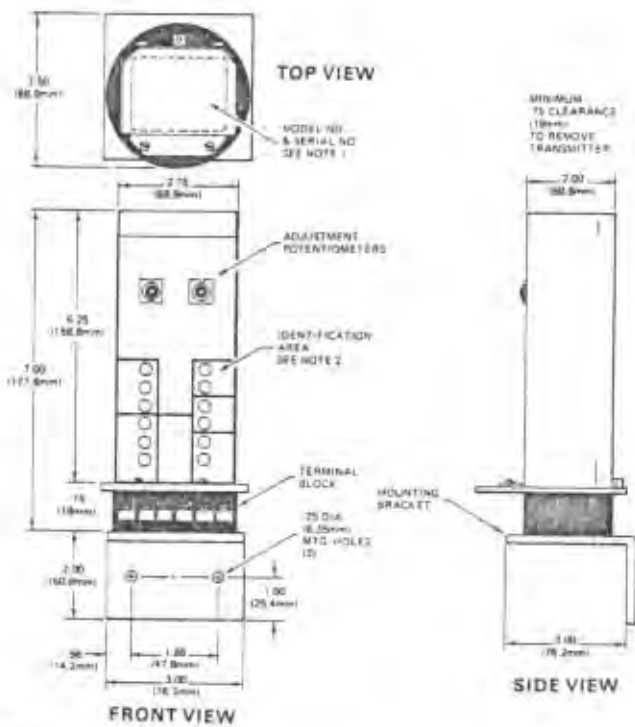

**NOTES:**

1. Identification area on top of unit case carries complete model number and serial number.
2. Identification area on front of transmitter case gives electrical connection information.

**Figure 3-5. Standard Unit With Plug-In STD Transmitter (PST) Option, Outline and Dimensions**

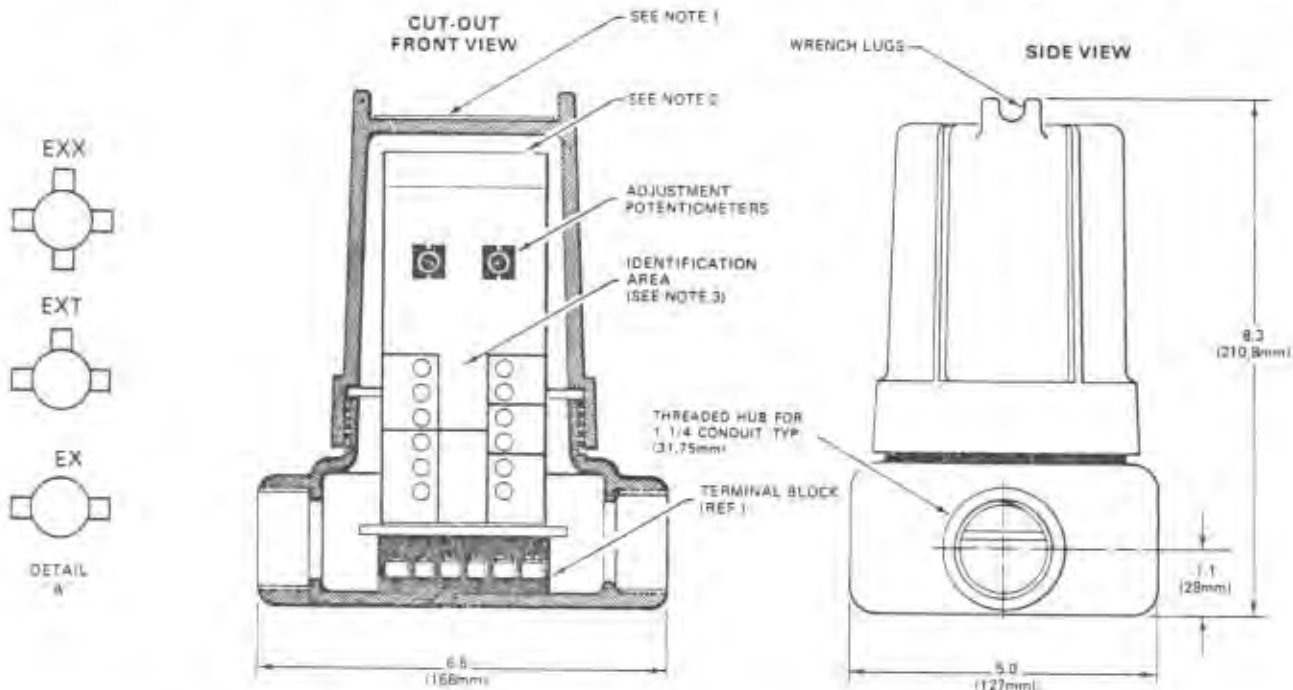

**NOTES:**

1. Top of cover has metal label carrying unit type (e.g., TCT, MVT) and equipment number (if any).
2. Identification area on top of unit case carries complete model number and serial number.
3. Identification area on front of unit case gives electrical connection information.
4. 'EX' housing (two conduit hubs) is shown above. Similar housings with three or four hubs is illustrated in detail A. Housings are cast aluminum alloy and meet NEMA specifications for Class I, Groups C and D and Class II, Groups E, F, and G.

**Figure 3-6. Standard Unit in Explosion-Proof Enclosure, Outline and Dimensions**

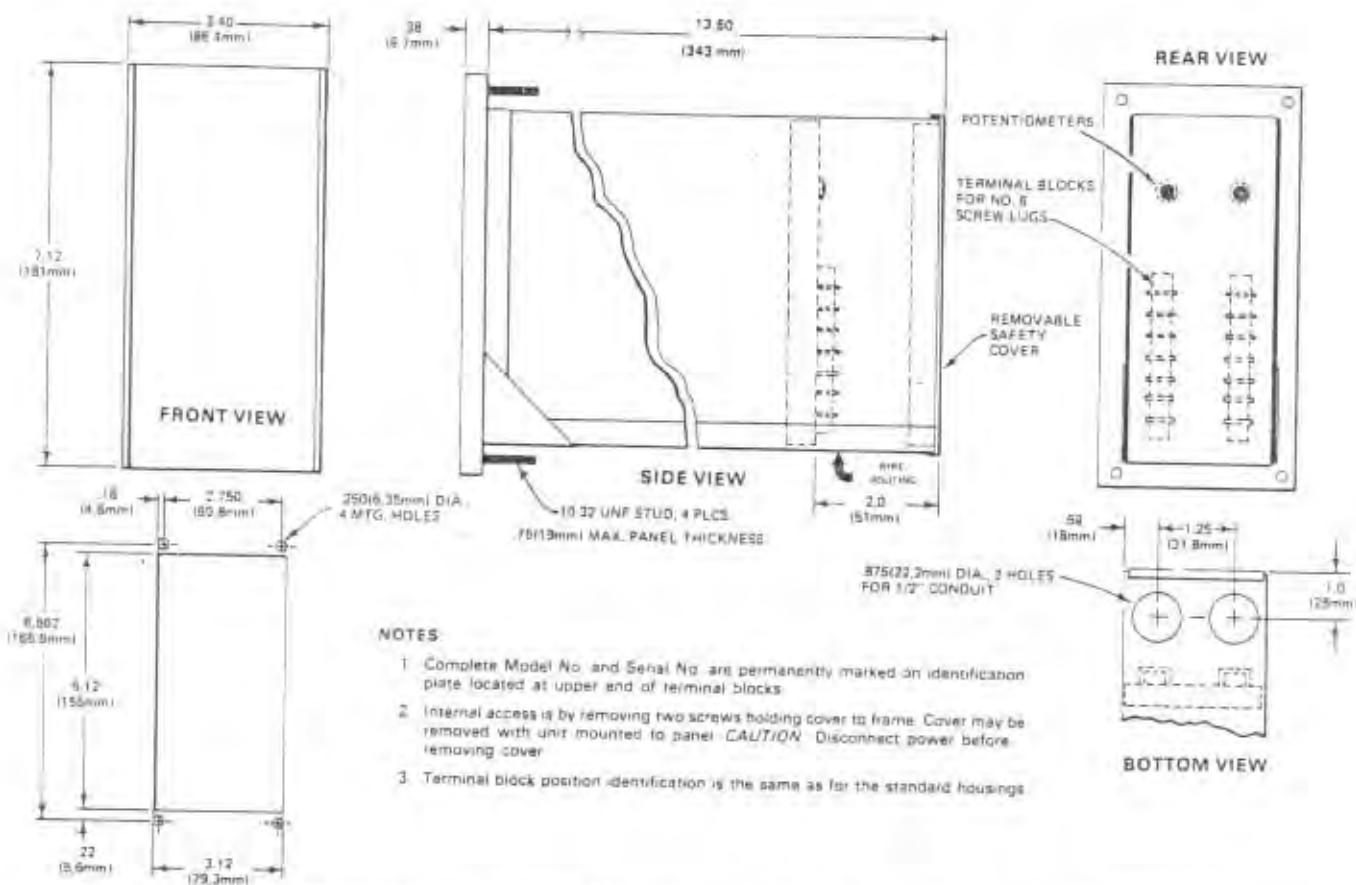

Figure 3-7. Standard Unit with Panel Mount Enclosure (PM) Option, Outline and Dimensions

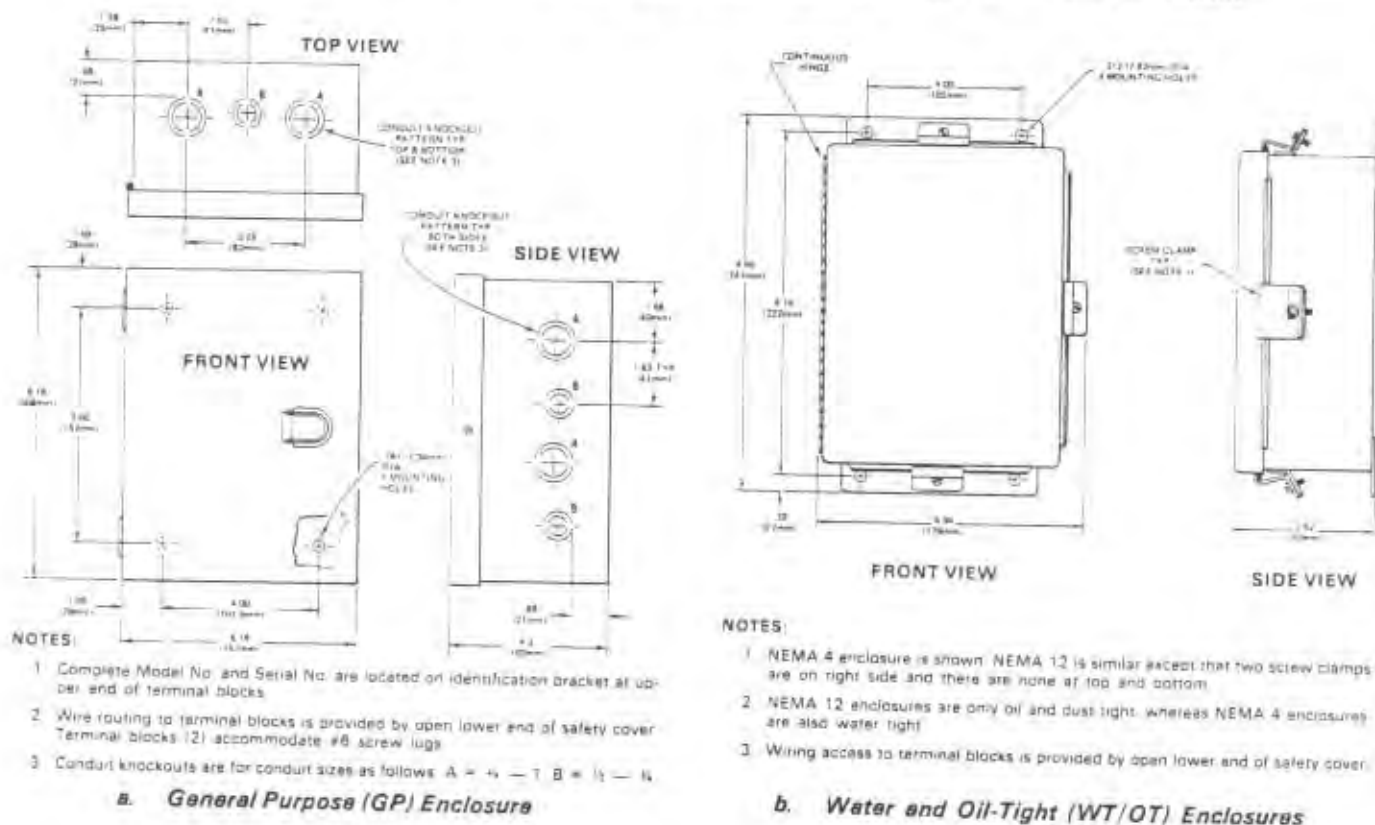
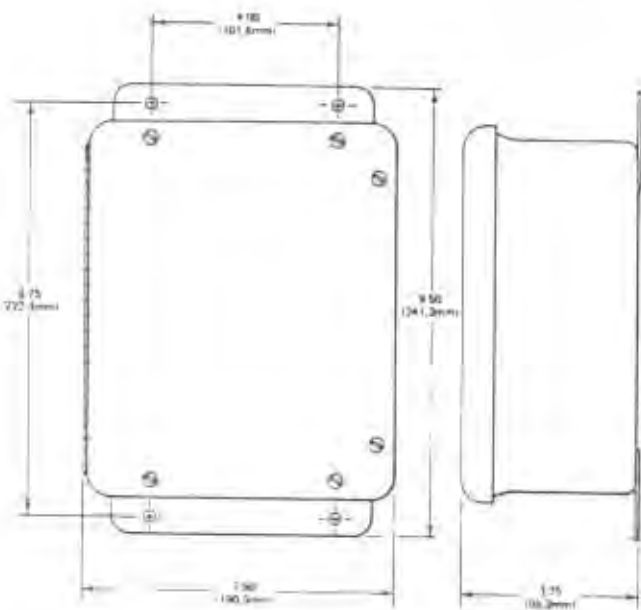

Figure 3-8. Standard Unit in NEMA Boxes, Outline and Dimensions



FRONT VIEW

SIDE VIEW



NOTES

1. All exposed metal hardware is type 302 stainless steel. Boxes are hinged on the long side unless otherwise specified.
2. All boxes include a one piece closed cell neoprene gasket.
3. Standard color is machine tool grey. Boxes are molded from pigmented polyester resins with the color throughout the box wall for a maintenance-free installation.

c. Corrosion-Proof (FG) Enclosure

Figure 3-8. Standard Unit in NEMA Boxes, Outline and Dimensions (Cont.)

FRONT VIEW

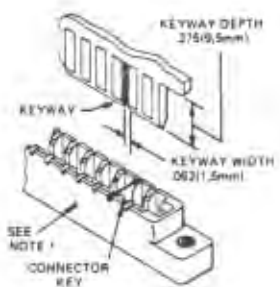

ADJUSTMENT POTENTIOMETERS MODEL NO. LABEL

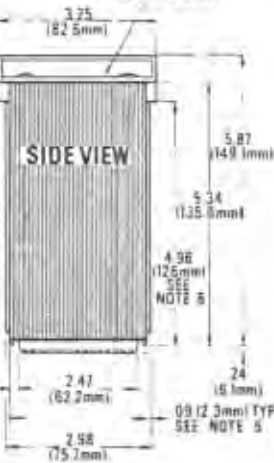

NOTES

1. Connectors used must have contacts on .156 (3.96mm) centers, with contacts for both surfaces of board (recommended type: Viking part no. 2VK135/1-2).
2. Maximum card insertion depth in connector is .350 (8.89mm).
3. Minimum width of connector insertion slot is 2.470 (62.70mm).
4. Removable plastic safety cover, 2.800 (71.12mm) wide.
5. Maximum card edge-guide insertion depth is .09 (2.29mm). Guides must be non-conductive.
6. Card edge-guides cannot extend beyond here.
7. Card extender part no. 350-513-00 is available for testing unit while in operating position.

Figure 3-9. Plug-In Unit, Outline and Dimensions

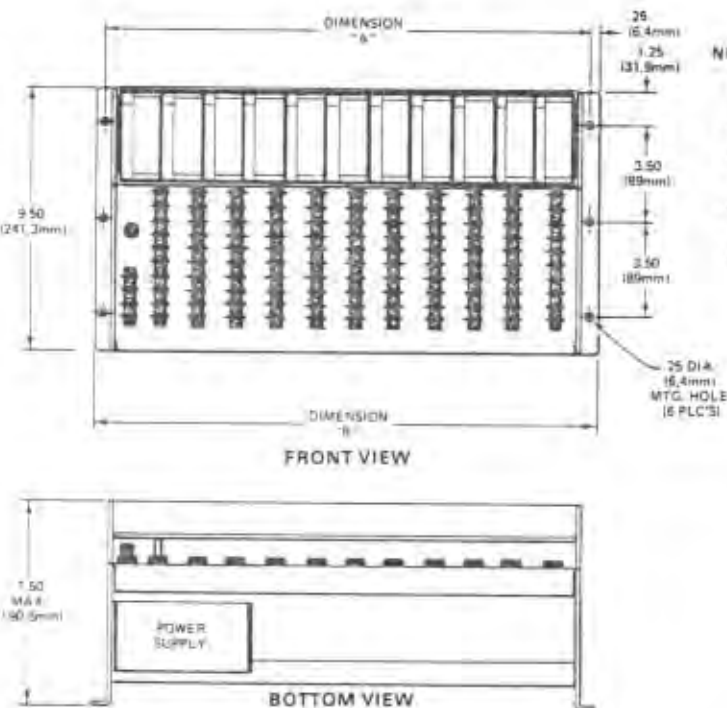

NOTES

1. M11 surface mounted card rack accommodates as few as 5, and as many as 15 plug-in units.
2. Empty positions may be closed by means of filler cards, P/N 350-213-00.
3. Connections are keyed to assure units will be plugged into proper position. Keying may be changed in the field if the system configuration changes.
4. Eleven position card rack is illustrated. Dimensions for mounting larger or smaller racks may be found in the table.
5. 24V power supply, shown, is capable of powering all models in card rack. Input specification, 117 VAC  $\pm$  10% 50/60 Hz. approximately 40 watts.

SIDE VIEW

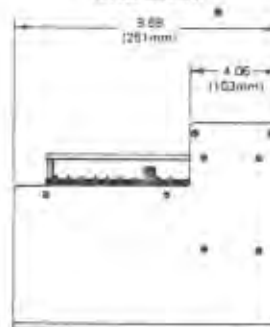

NUMBER OF POSITIONS	DIMENSION			
	A	mm	B	mm
5	9.19	233.4	9.50	241.1
6	10.82	269.7	11.12	282.4
7	12.06	306.3	12.50	318
8	13.50	342.9	14.00	355.6
9	14.34	378.5	15.44	392.2
10	16.38	415	16.58	428.8
11	17.81	452.4	18.21	465
12	19.25	489.7	19.75	501.7
13	20.69	526.5	21.19	538.2
14	22.12	561.8	22.62	574.5
15	23.66	598.4	24.06	611.1

Figure 3-10. Surface Mounted Card Racks (SMR), Outline and Dimensions

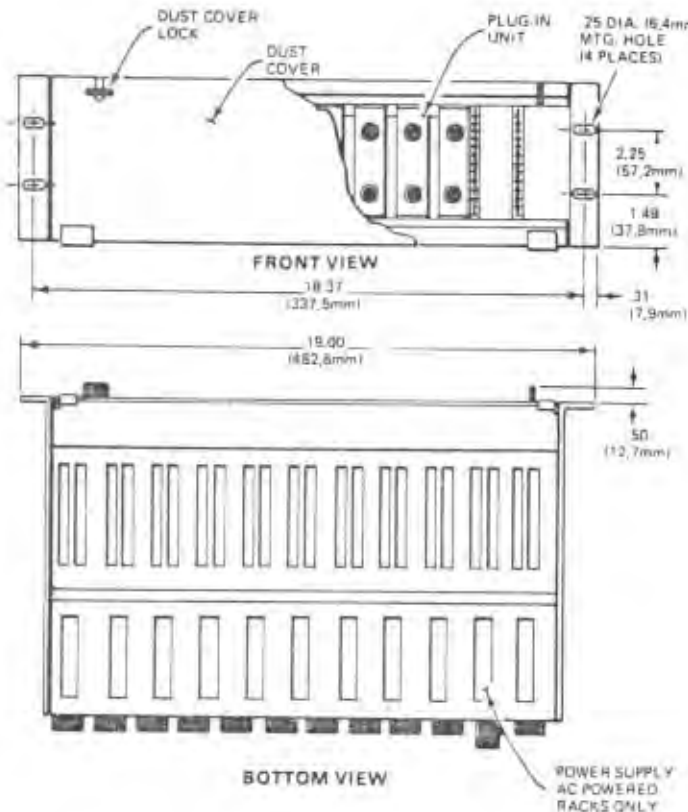

**NOTES:**

- 1 Connectors are keyed to assure units will be plugged into proper position. Key-  
ing may be changed in the field should the system configuration change.
- 2 This enclosure is designed to mount in a standard 19-inch rack with EIA hole  
pattern.
- 3 Surface mounting card racks for use in NEMA type enclosures are also available.  
Contact factory for further details of card racks and card rack assemblies.
- 4 Barrier strip connectors are CSA approved.
- 5 Empty positions may be closed by means of filler cards. Part No. 350-211-00,  
which must be ordered individually in quantity required.
- 6 24 volt power supply furnished capable of powering a typical complement of up  
to fifteen modules. Input specification 117 volts  $\pm$  10% 50/60 Hz approximately  
40 watts.

**a. Eleven-Position Card Rack**

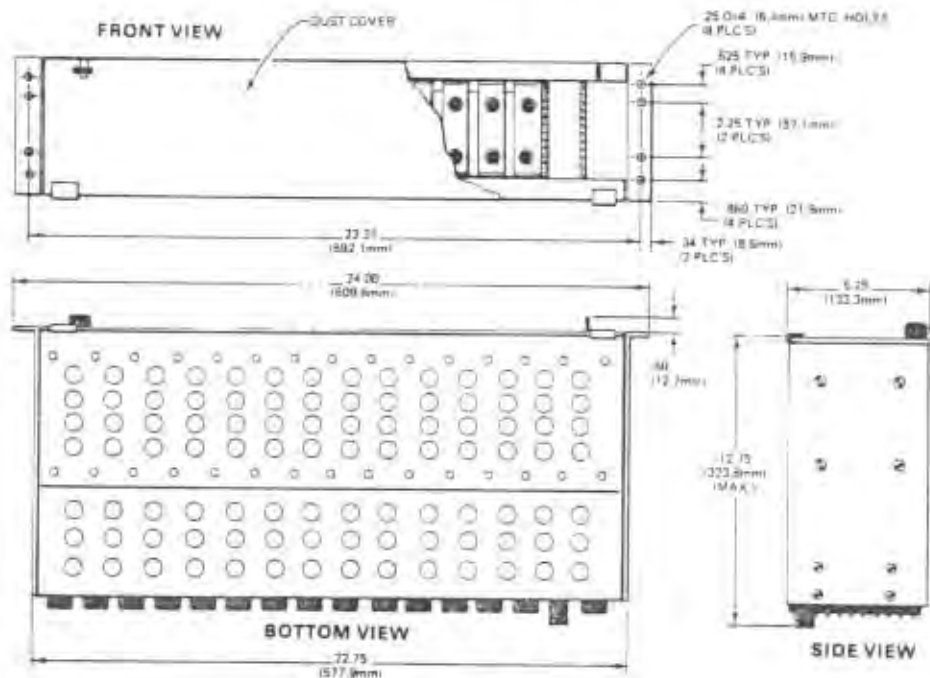

**b. Fifteen-Position Card Rack**

**Figure 3-11. Rack-Mounted Card Racks (RMR) Enclosure, Outline and Dimensions**

### 3.2 ELECTRICAL CONNECTIONS

All electrical connections to standard units are made to the terminal blocks on the unit. On plug-in units, the electrical connections are made to terminals on the mating connector for the unit. Terminals used for standard units and their options are defined in the following paragraph.

#### 3.2.1 General Wiring Information

No special wire or cable is required for signal connections to the unit. To avoid transients and stray pickups, it is recommended that twisted conductors be used where they are run close to other services (such as power wiring). Electrical connections to the units fall into two major categories: connections to all standard units with terminal blocks, and connections to plug-in units and their associated enclosures.

*Wiring Information for All Standard Units With Terminal Strips and Blocks.* Standard units with terminal strips or terminal blocks have terminals supplied with 6-32 screws long enough to easily accommodate three spade-lug connectors. Standard units with snap-off plastic covers have an opening in the bottom of the cover. Dress all wiring to and from the terminals through this opening. Spade lug connectors are recommended for all wire terminations. Figure 3-12 illustrates the

terminal strip locations and identification for the standard units and the terminal block identifications for the explosion proof and PST configurations. Table 3-1 provides the complete labeling nomenclature for standard unit and any available electrical options. Terminal labeling appears next to the terminal it identifies on standard units. For PST and explosion proof units, terminal labeling is marked on the front of the unit housing with the referenced terminals identified numerically.

*Wiring Information for All Units in NEMA Boxes.* Units mounted in NEMA boxes are standard units with or without the options listed in Table 3-1. NEMA boxes for OT or WT options do not have conduit holes fittings or knockouts. Conduit access must be provided by fittings such as Myer Scru-Tite or equivalent.

General Purpose (GP) enclosures have conduit knockouts for various sizes of conduits from 1-inch down to 1/2-inch. Corrosion-Proof (FG) enclosures require special attention with ground connections. Since enclosure material is polyester resin, conduit cutouts may be cut with a punch or hole saw. Ground continuity may be obtained in two different ways. If a metal panel is used, ground can be made between the metal con-

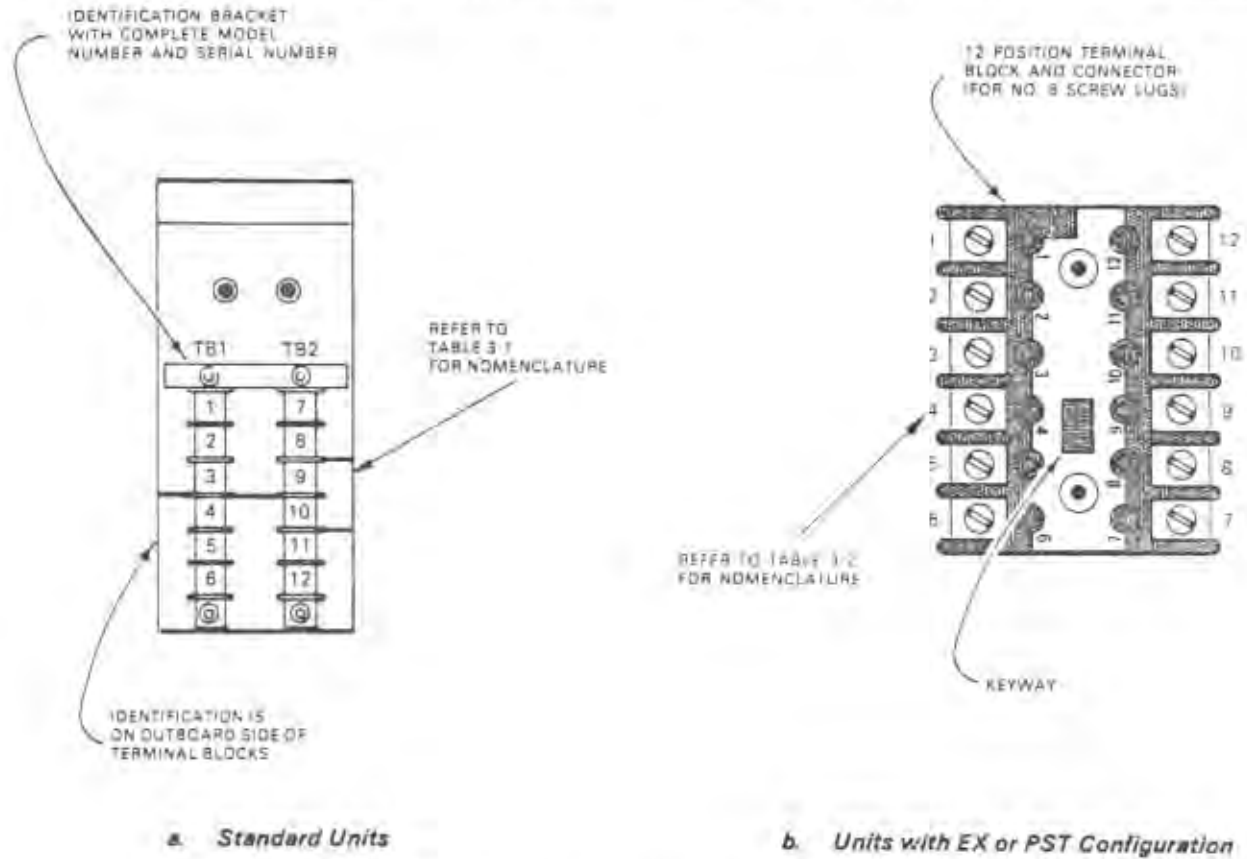

Figure 3-12. Terminal Strips and Terminal Blocks Identification

TABLE 3-1. TERMINAL NOMENCLATURE

Options (Note 1)	Terminal Positions (See Figure 3-12)											
	1	2	3	4	5	6	7	8	9	10	11	12
NONE		GND		(-) DCC	(+) DC		+A	-A	+B	-B	(+) OUT	(-) OUT
AC				ACC	AC		+A	-A	+B	-B	(+) OUT	(-) OUT
SC (Output)		SC	SC									
SC (Input) (Note 2)												
TX		+TX										

**NOTES:**

1. Labeling shown here may be combined. The combination may include standard labeling and one or more options. Combinations of options may cause labeling positions to change, but nomenclature will remain as shown.
2. Terminal nomenclature not affected by this option. SC resistor is mounted across +A and -A or across +B and -B terminals.

**Legend:**

DC	+DC Power Input	±A	A Signal Input
DCC	-DC Power Input	±B	B Signal Input
GND	Chassis Ground	±OUT	Signal Output
AC	AC Power Input	SC	SC Resistor
ACC	AC Power Return	+TX	Excitation Power Output

duit locknut and the panel at enclosure entry and exit. If the enclosure is used without the back panel, a jumper between the conduit entry and exit is necessary to maintain ground continuity. Remove snap-off plastic cover to access terminal strips.

*Wiring Information for Plug-In Units.* Plug-in units and card rack electrical connections are made to terminals on the mating connector for the unit or the card rack terminal strips. Figure 3-13 illustrates the terminal strip connections and their

numerical reference designator. Table 3-2 provides a complete terminal nomenclature for both Plug-In and Rack assemblies.

**3.2.2 Power Connections**

Units are designed to operate from either a DC or AC power source. Refer to paragraph 1.6 for information on how to use the model number to determine the type of power required.

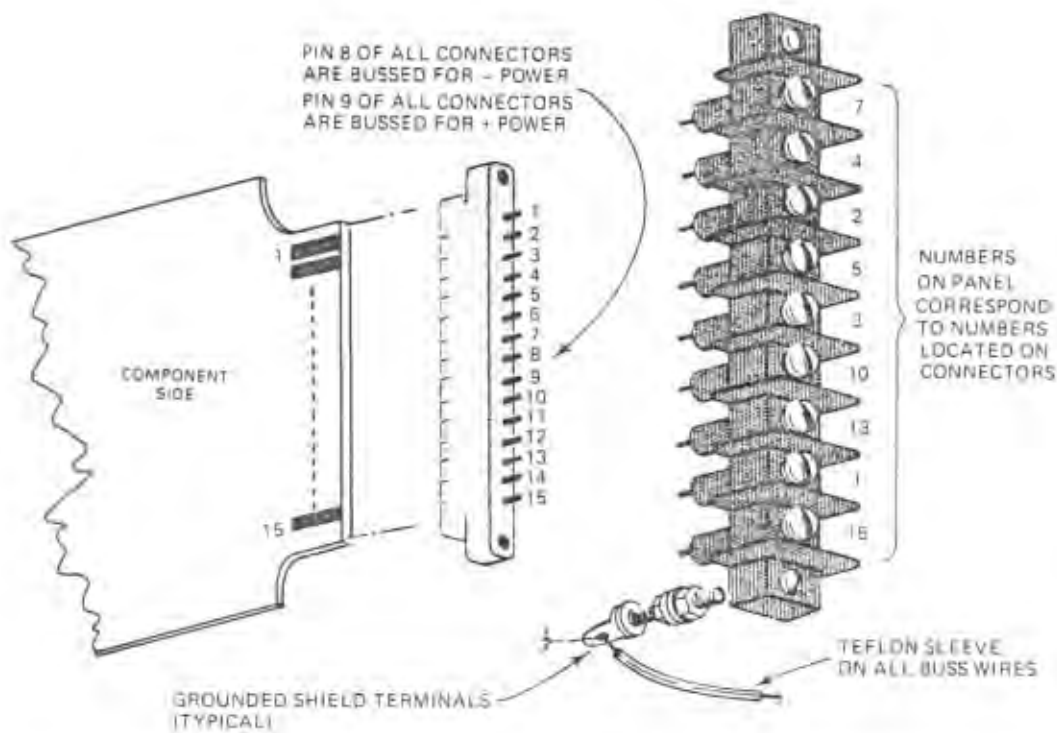

Figure 3-13. Plug-In Connectors and Terminal Strips Wiring and Identification

TABLE 3-2. CONNECTOR PINS AND TERMINAL ASSIGNMENTS FOR PLUG-IN UNIT AND CARD RACKS

Options	Terminal Positions (See Figure 3-13)														
	1	2	3	4	5	6	7	8	9	10	11	12	13	14	15
NONE	+B		+A	(+) OUT			(-) OUT	(-) DCC	(-) DC	-A					-B
SC (Output)		SC			SC										
TX					+TX										

KEYWAYS

**Legend:**

DC	+DC Power Input	± B	Signal Input
DCC	-DC Power Input	± A	Signal Input
GND	Chassis Ground	± OUT	Signal Output
+TX	External Excitation Power Output	SC	Selectable Current Resistor

### 3.3 OPERATION AND PERIODIC OBSERVATION

Once calibrated and installed, the unit may be operated unattended. The only controls on the outside of the unit are the SPAN and ZERO potentiometers, which, after initial adjustments, need no further attention. There are no indicators on the unit. Because the circuit uses highly reliable solid-state components with no moving parts, the unit should operate virtually maintenance-free for a long period of time. However, if a malfunction

should occur, refer to Section 5 for maintenance information.

A periodic check of input and output connections is recommended every six months to ensure continued dependability of operation.

A unit may become warm during operation, especially where the ambient temperature is rather high. This is perfectly normal and should not be a cause for alarm unless a malfunction is also observed.

*DC-powered units.* On these units the DC terminal is connected to the + (positive) side of the source, and the DCC terminal is connected to the — (negative) side. The DC source should be regulated to within  $\pm 10\%$  of the nominal voltage and should be capable of delivering 5 watts.

*AC-Powered Units.* These units require 117 volts AC  $\pm 10\%$ , 50/60 Hz at 5 VA of nominal power or 220/240 VAC optionally. The AC terminal should be connected to the ungrounded or "hot" side of the supply, if possible, and the ACC terminal is connected to the common or neutral. The GND terminal is the mechanical case connection.

*Rack Power Connections.* Connect power input wires to the appropriately labeled terminals of the 3-terminal connector strip. The third terminal on strip is chassis ground.

### 3.2.3 Connections On Units With SC Option

On units with the SC (selectable current) option, connect the input selectable current resistor to the +A and —A terminals. Connect the output selectable current resistor to the terminals marked SC, or those specified in Table 3-1. The current range is marked on the body of each resistor. If provided, the selectable current resistors for a plug-in unit should be mounted externally either at the terminal block of the card rack, or soldered to the appropriate terminals on the PC connector. See Table 3-2 for correct connections.

### 3.2.4 Connections on Units With TX Option

On units with TX option, connect the positive output lead from the field mounted transmitter to the +TX terminal on the unit. Connect the minus output lead from the transmitter to the +A input on the unit. Figure 3-14 illustrates this connection. Numbers in parentheses refer to plug-in units.

## 3.3 OPERATION AND PERIODIC OBSERVATION

Once calibrated and installed, the unit may be operated unattended. The only controls on the outside of the unit are the SPAN and ZERO potentiometers, which, after initial adjustments, need no further attention. There are no indicators on the unit. Because the circuit uses highly reliable solid-state components with no moving parts, the unit should operate virtually maintenance-free for a long period of time. However, if a malfunction should occur, refer to Section 5 for maintenance information.

A periodic check of input and output connections is recommended every six months to ensure continued dependability of operation.

A unit may become warm during operation, especially where the ambient temperature is rather high. This is perfectly normal and should not be a cause for alarm unless a malfunction is also observed.

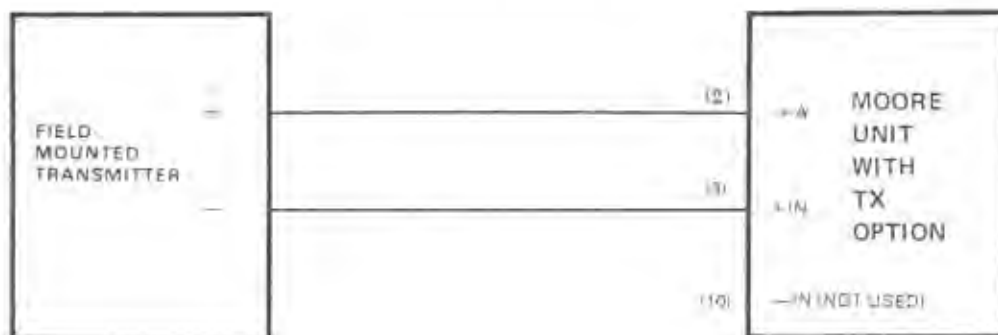

Figure 3-14. TX Option Connections

## THEORY OF OPERATION

### 4.1 INTRODUCTION

This section describes the unit operation. An overall view of the unit function based on the block diagram of Figure 4-1 introduces the user to the unit functional elements. This functional analysis is further detailed in the circuit description paragraphs that follow. Each of these paragraphs also contains a detailed description of the circuit operation. These descriptions are based on the schematic diagram included in Section 6, Unit Documentation.

Components reference designators are listed here for both standard and plug-in models. The standard unit reference designator is listed first. This information is followed by the reference designator for the plug-in unit in parentheses and italics. If both reference designators are the same, it is listed only once.

A rapid familiarization of the unit can be obtained by reading the general functional description (paragraph 4.2) and the functional section of the circuit description paragraphs entitled "General." The "Detailed" section of these paragraphs provides sufficient data so that troubleshooting, if required, can be performed intelligently and rapidly.

### 4.2 EQUIPMENT FUNCTIONAL DESCRIPTION

The A input signal (as a percent) is applied to a buffer input amplifier, and the proportion of a constant voltage that drives a following stage is controlled by solid-state switches. The B input signal (as a percent) controls the frequency and amplitude of a ramp generator in the unit. The amplitude of the ramp is compared with the amplitude of the A input signal in a comparator that provides drive to the switches. The method of generating the drive to the switches and the arrangement of the switches themselves cause the drive from the A buffer amplifier to the following stage to be proportional to the span of the A input signal divided by the span of the B input signal. This driving signal is linearly amplified to produce an output that is likewise proportional to this same quotient.

### 4.3

*General:* Units are supplied for use with either an AC or DC power input. On units intended for a DC power input, the power is applied directly to the input of the power inverter (see paragraph 4.4), with diode protection to prevent damage to the power inverter components, if the DC power input is accidentally connected with reversed polarity.

A 400 milliamp fuse may be placed in series with the +DC input as illustrated in schematic diagram 195-451-00. This configuration, used in the fuse option (FU), protects the unit from damage where DC voltage may fluctuate enough to cause excessive current drain on the unit.

*Detailed:* Units operated from an AC power source use a power supply consisting of a power transformer, rectifier and filter to produce a DC output. Referring to the schematic diagram, VS1 is connected across the primary of power transformer T1 and suppresses transients that may be

present on the power line. The output from the secondaries of T1 is rectified by CR8, a full-wave rectifier bridge, thus producing a pulsating DC voltage applied to the input of the regulator filter board PC2.

### 4.4 DESCRIPTION OF POWER INVERTER CIRCUIT (Standard and Plug-In Units)

*General:* The power inverter is a transformer-coupled multivibrator oscillating at approximately a 3 KHz rate. Because the core of the transformer is saturated, a square wave of reasonably constant amplitude is generated. This signal can be observed at the collector of Q1 or Q2. The transformer has four secondary windings isolated from each other. Only two of these are used to produce in-

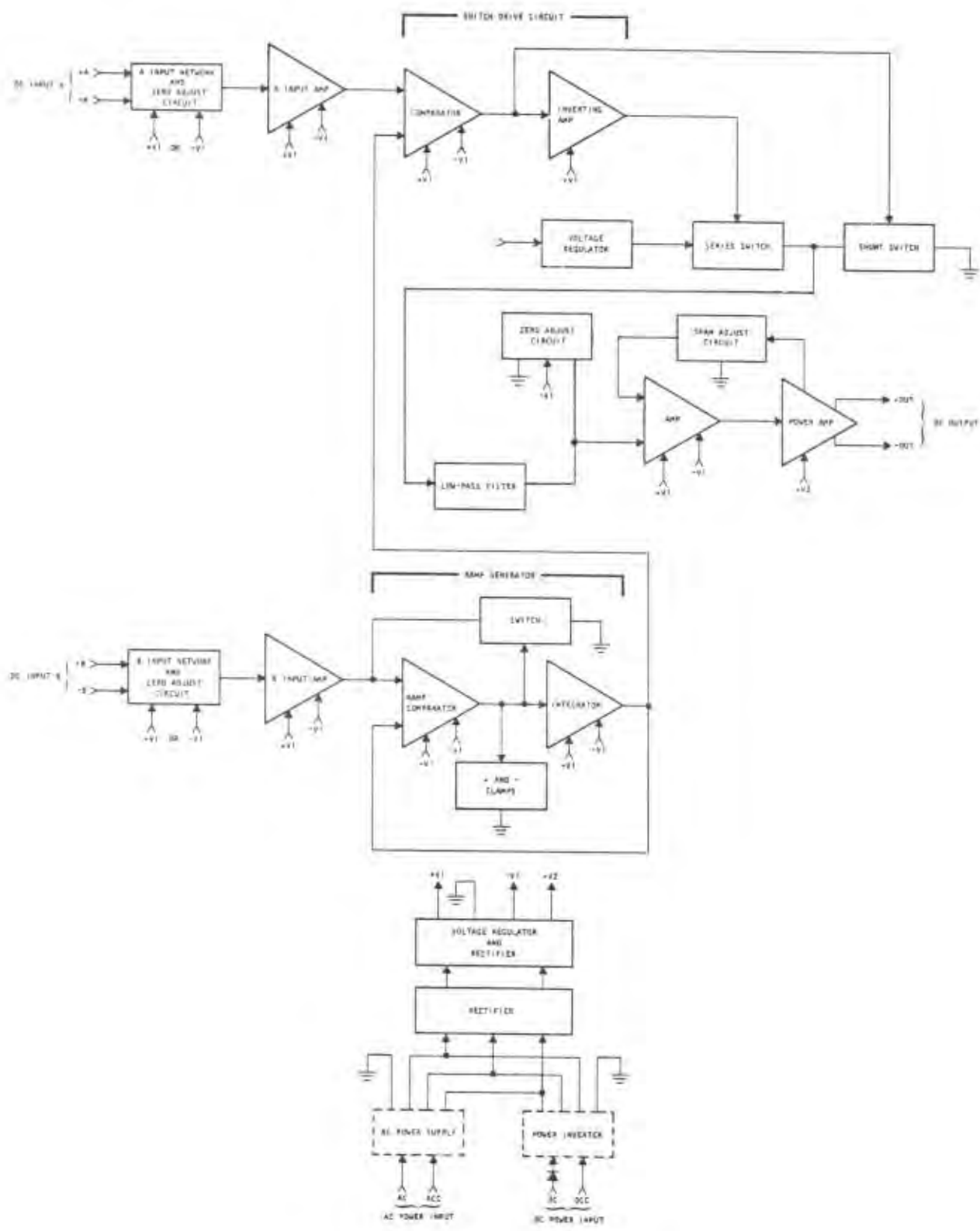

Figure 4-1. ADB Functional Block Diagram



dependent square wave outputs. These outputs, instead of the outputs from the AC power supply, are then applied to the rectifier and regulator, which function in the usual manner. A diode in the DC (positive) lead will prevent damage to components in the power inverter if the DC primary source is accidentally connected with incorrect polarity.

*Detailed:* The components of the power inverter are mounted on a printed circuit board attached to the main board for standard units and are mounted directly on the main board for plug-in units. Drawing 400-404-00 is the schematic diagram of the power inverter (PCA) used on a standard unit. When a standard unit is ordered for use with DC power, the power inverter is used instead of the AC source T1 shown on the unit schematic diagram. The DC applied to the power inverter is converted to a square wave of approximately 3 KHz by Q1, Q2, and the primaries of T1, functioning as a DC-to-AC inverter. Filter L1-C4 (C11) prevents the 3-KHz signal from getting back into the external DC source. CR1 (CR3) provides protection against damage from inadvertent application of DC of incorrect polarity. The square-wave output from center-tapped secondary 8-13 is applied to CR5 and CR7 (CR6, CR7), and that from secondary 17-18 is applied to a half-wave rectifier CR201 (CR8).

#### 4.5 DESCRIPTION OF RECTIFIER AND REGULATOR CIRCUIT

*General:* The rectifier accepts the outputs from either the AC power supply or the power inverter and produces unregulated positive and negative voltages (of equal value with respect to ground). The regulator reduces these voltages to the required operating values and regulates them against changes with load or line-voltage changes. Although physically on the regulator assembly, another rectifier produces a higher unregulated output as operating voltage for the power amplifier.

*Detailed:* On all standard units, the components of the regulator circuit are mounted on a printed circuit board attached to the main board, while the main rectifier is mounted on the main board. On plug-in units all components are mounted on the main board. CR6 used in the AC power option of standard units only (unit schematic diagram) consists of two sets of full-wave rectifiers arranged to produce both positive and negative DC outputs

(with respect to the grounded center tap of the transformer winding that feeds the rectifier). The positive and negative DC outputs from CR6 for AC power option or from CR5 and CR7 (CR6, CR7) for DC power input, are applied to pins 5 and 6 of the power supply regulator for standard units only. On standard units the regulator consists of two filters and voltage regulators, one each for the positive and negative outputs from CR6 and a half-wave rectifier and filter. On plug-in units, the regulator consists of zener diodes CR4, CR5, and pass transistors Q4, Q3. The unfiltered positive output from CR6 (CR5, CR7) or from the PCA on standard units DC power input, is filtered by C203 (CR8) and then regulated to +12 volts output by pass transistor Q202 (Q4), the base of which is clamped at 12 volts by CR203, (CR5).

Similar action to produce -12 volts output is accomplished by C202 (C7), Q201 (Q3), and CR202 (CR4). Half-wave rectifier CR201, CR204 (CR8) and filter C201 (C10) produce a higher unregulated positive voltage (approximately +38 volts) from the transformer winding that is not center-tapped. This higher voltage is used to power the output amplifier.

#### 4.6 RAMP GENERATOR CIRCUITS DESCRIPTION

*General:* The ramp generator produces a periodically varying signal that is compared against the A-signal amplitude with the live zero modified. The resulting signal from the comparator then drives switches that control the time during which a constant-amplitude signal is applied to the following amplifier. Because of the way the ramp generator and the switches are controlled by the input signals, the resulting DC signal applied to the amplifier is proportional to the quotient of the A by the B signal amplitudes (with the live zero modified).

The ramp generator produces an output that periodically increases at a constant rate to a controlled maximum positive value and then decreases at the same rate to ground (zero) potential. The maximum positive amplitude reached before the output begins to decrease is controlled by the amplitude of the span of the B input signal. As the span of the B input signal increases, the amplitude of the ramp signal increases. Since the rate of rise (and fall) of the ramp output is constant regardless of the amplitude, the time required to

reach the maximum positive amplitude must increase as this amplitude increases. This means that the time required to complete a ramp cycle (i.e., the ramp period) increases with an increasing span of the B input signal. The output of the ramp generator is applied to one side of the comparator that produces the basic drive signal for the switches that control the signal applied to the output amplifier.

The main elements of the ramp generator are a ramp comparator and an integrator. This circuit also includes a switch and plus and minus clamps. To begin the description of operation, we shall assume, arbitrarily, that the output of the ramp comparator is initially at a fixed negative value determined by the negative clamp. This output is applied to the switch, keeping it turned off, and also to the integrator, causing it to produce an increasing output. The span of the B input signal, buffered by the B input amplifier, is applied to one side of the ramp comparator, and the rising integrator output is applied to the other side. When the rising integrator output just equals the span of the B input signal applied to the opposite side of the ramp comparator, the output of the ramp comparator rapidly changes to a fixed positive value, thus turning on the switch and removing the span of the B input signal as one input to the ramp comparator. This same positive output from the ramp comparator also drives the integrator and causes its output to decrease toward zero.

With the switch turned on, the ramp comparator is driven only by the decreasing output of the integrator. When the integrator output reaches zero, the output of the ramp comparator rapidly changes to its negative value, turning off the switch and again allowing the span of the B input signal to control the ramp generator. Thus, a new ramp cycle is initiated.

Note that the polarity of the output from the ramp comparator determines whether the ramp output is increasing or decreasing. As stated previously, also note that the amplitude to which the ramp output rises and the time for a ramp period are directly proportional to the span of the B input signal. How these facts are used to obtain an output proportional to the quotient  $A/B$  is explained later.

*Detailed:* In the ramp generator, IC3 (IC4) and associated components from the ramp comparator, Q1 (Q8) serves as the switch, and IC1 (IC6) and its associated components act as the integrator. A signal derived from the span of the B input signal from IC2 (IC3) is applied through R35 (R59) to pin 2 (the inverting input) of IC3 (IC4). If the ramp signal applied to pin 3 of IC3 (IC4) from the output of IC1 (IC6) is assumed, for the

moment, to be less than the signal applied to pin 2, IC3 (IC4) will be driven primarily by the positive signal applied to pin 2 and thus produce a negative output signal at pin 6. This negative output is applied through R19 (R46) to the base of Q1 (Q8) and turns off this switch. CR1 (CR12) limits the negative voltage that can be applied to the base of Q1 to approximately 0.6 volt. The output from IC3 (IC4) is also applied through R2 (R47) to CR2 (CR11) and clamped at this point to  $-6.2$  volts. The clamped signal is applied through R3 (R48) to pin 2 (the inverting input) of IC1 (IC6). Under the influence of this signal and the action of C1 (C6), IC1 (IC6) produces an output that begins to rise at a constant rate, and this output is applied through R34 (R24) to pin 3 of IC3 (IC4). When the rising signal at pin 3 of IC3 (IC4) becomes greater than the positive signal (obtained from the B input) applied to pin 2, the output of IC3 (IC4) rapidly changes to a positive value. This positive output of IC3 (IC4) turns on Q1 (Q8) which short circuits pin 2 of IC3 (IC4) to ground and thus removes the effect that the span of the B input signal had in controlling the action of the ramp comparator. Now feedback from the integrator output to pin 3 of IC3 (IC4) regeneratively locks IC3 (IC4) to keep its output positive (under the conditions just described). The positive output of IC3 (IC4) is clamped to  $+6.2$  volts by CR3 (CR10), and the resulting positive signal is applied to pin 2 of IC1 (IC6). Since the signal applied to the inverting input of IC1 (IC6) is now positive, the output of IC1 (IC6) begins to decrease at the same rate it originally increased to its maximum positive value. Because pin 2 of IC3 (IC4) is grounded by Q1 (Q8) (which is now turned on), the output of IC3 (IC4) will remain positive until the ramp output from IC1 (IC6) reaches zero. When this occurs, the output of IC3 (IC4) again reverses polarity and becomes negative, turning off Q1 (Q8) and starting a new ramp cycle. Both IC3 (IC4) and IC1 (IC6) operate from  $+12$  volts and  $-12$  volts.

#### 4.7 SWITCH DRIVE CIRCUITS DESCRIPTION

*General:* The switch drive circuit consists of a comparator and an inverting amplifier. One side of the comparator is driven by the span of the amplified A input signal, and the other side is driven by the output from the integrator in the ramp generator. As long as the drive from the ramp generator is less than that from the span of the A input signal, the comparator produces a negative output that turns off the shunt switch and inverting amplifier. The output at the inverting amplifier turns on the series switch. When the output of the ramp generator becomes slightly greater than the signal produced by the span of the A input signal, the comparator produces a positive

output that turns on the shunt switch and the inverting amplifier, thus turning off the series switch. The switches remain in these states until the ramp output again falls below the value of the span of the A input signal, at which time the series switch is again turned on and the shunt switch turned off. The process then repeats.

*Detailed:* The switch drive circuit consists of comparator IC6 (IC2) and inverting amplifier Q2 (Q7). A signal derived from the A input signal is applied through R38 (R29) to pin 2 (the inverting input) of IC6 (IC2), and the ramp output from IC1 (IC6) is applied through R20 (R25) to pin 3. When the ramp signal is just beginning to rise from ground, it is less positive than the signal applied to pin 2. Under this condition, IC6 (IC2) produces a negative output that is applied through R21 (R18) to turn off Q3 (Q5), and is also applied through R1 (R31) to turn off Q2 (Q7). With Q2 (Q7) off, the positive voltage at its collector is applied through R22 (R42) to Q4 (Q6), turning on this transistor. Q4 and Q3 (Q6, Q5) remain in their respective on and off states until the ramp output from IC1 (IC6) becomes just slightly greater than the signal applied to pin 2 of IC6 (IC2) and causes this comparator to reverse the polarity of its output. At this point, Q4 and Q3 (Q6, Q5) reverse their states and remain in their new states until the ramp output again becomes less than the signal applied to pin 2 of IC6 (IC2). The comparator operates from +12 volts and -12 volts, and Q2 (Q7) operates from +12 volts.

#### 4.8 A AND B INPUT NETWORKS AND ZERO ADJUST CIRCUITS DESCRIPTION

*General:* The A and B inputs each have an input network and zero adjust circuit. Each input network provides the corresponding input signal with the proper termination and combines that signal with the voltage from the associated zero adjust circuit. Each zero adjust circuit adds to the corresponding basic input signal a voltage adjusted to modify the live zero (if present) of that basic input signal to accommodate the range of the physical quantity that the input signal represents. Thus, only the modified span of the basic input signal is effective in driving the remainder of the unit, and the resulting span of each input signal is applied to an input amplifier. Each zero adjust circuit can be wired to operate from either the +V1 or -V1 voltage, according to the type of

input signal applied and the specific application of the unit.

*Detailed:* Since the function of the components in the input circuits for both the A and B signals is the same (for a given configuration), only the A network and zero adjust circuit will be described in detail, except where differences in component values are significant. The corresponding functions for the B signal can be obtained by inspection of the schematic diagram. Because the particular application of the unit determines the configurations of the input circuits, only the configuration for a specific application (i.e., flow computer) will be described in detail. Other possible configurations are given in the Option Revision Notice marked on the main schematic diagram.

R10 (R56) provides a current A input signal with the proper termination. For a current A input signal in the configuration for a flow computer, the A zero adjust circuit consists of R41 (R3), the A INPUT ZERO adjust potentiometer and R42 (R4) in series, connected across +6.2 volts. The +6.2 volts is regulated by CR4 (CR2) and derived through R30 (R23) from +12 volts. The A INPUT ZERO potentiometer is adjusted so that the voltage at its wiper, when combined through R26 (R1) with the A input signal at pin 2 of IC4 (IC1), produces the necessary total signal at this pin to allow the unit to develop the required output. For KA option or zero based input signals, THE A INPUT ZERO adjust circuits may be wired to operate from -6.2 volts. In this configuration, R42 (R4) is omitted. Instead, R45 (R5) is connected into the circuit. This signal is now regulated by CR9 (CR1) and derived through R47 (R22) from -12 volts. Regardless of the source of voltage with which it operates, the basic function of the A INPUT ZERO potentiometer is to effectively shift the span of the applied original A input signal so it corresponds to that of the physical quantity represented by that input signal. A similar function is performed by the B INPUT ZERO potentiometer.

#### 4.9 A AND B INPUT AMPLIFIERS DESCRIPTION

*General:* Each input amplifier is an operational amplifier used as a buffer to isolate the applied input signal from the following load. Each amplifier also provides a moderate amount of gain, depending on the kind and value of the applied input signal. Feedback is used to establish the amplifier

gain and also to achieve high stability of amplifier operation.

*Detailed:* IC4 (IC1) and IC2 (IC3) are the A and B input amplifiers, respectively. Each input signal with the live zero modified is applied through resistors R11 and R6 (R38 and R45) to pin 3 (the non-inverting input) of the corresponding amplifier. Feedback from the output at pin 6 is applied through a resistor to pin 2, and a resistor is connected from pin 2 to ground. The gain of the input amplifier is determined by the ratio of the values of the two resistors. The resistors have been chosen so the gains make the B signal from the output of IC2 (IC3) always greater than the A signal from the output of IC4 (IC1) for all possible values of A and B input signals. Each input amplifier operates from +12 volts and -12 volts.

#### 4.10 SWITCHES CIRCUITS DESCRIPTION

*General:* The switches, driven as described in paragraph 4.7, chop the output of the associated voltage regulator into a rectangular wave with an instantaneous value, at the junction of the switches, that is either the positive regulated output or zero. In general, the durations of these values are not equal. The switches are driven so the DC average value of the chopped regulator output is proportional to the quotient of the span of the A input signal divided by the B input signal applied to the unit. It should be noted that this average level of the rectangular wave does not appear at the junction of the switches, but is produced by a low-pass filter at the input of the following amplifier.

Several interrelated factors combine to produce a rectangular wave with positive- and zero-voltage durations such that the desired average value will be obtained. First, the average level is proportional to the time during which the series switch is on, relative to the time for one ramp cycle. This is true because it is during this time that the rectangular wave has a value equal to the output of the regulator. Because a signal proportional to the span of the A input signal drives one side of the comparator and the ramp output drives the other side, the fraction of the ramp period during which the series switch is on is inversely proportional to the span of the B input signal applied to the unit. This relationship is true because the comparator output must be less than the signal that is derived from the span of the A input signal, and because the maximum amplitude of the ramp and ramp period are both directly proportional to the span of the B input signal. From these facts, it is evident that the time, expressed as a fraction of the total ramp period, during which the comparator output

is less than the signal derived from the span of the A input signal is inversely proportional to the span of the B input signal and directly proportional to the span of the A input signal. Therefore, the time during which the series switch is on follows this same relationship. Thus, the DC average value of the rectangular wave produced by the switches is proportional to the quotient of A divided by B, where A and B are the spans of the corresponding input signals. The regulated voltage with which the series switch operates is derived from the +V1 voltage, and the DC average level that is produced at the input of the amplifier is used to operate the shunt switch.

*Detailed:* Q4 (Q6) is the series switch and Q3 (Q5) is the shunt switch. A fixed voltage of +6.2 volts, regulated by CR8 (CR9) are derived through R36 (R44) from +12 volts, is supplied to the collector of Q4 (Q6). When this transistor is on and R36 (Q5) is off, the +6.2 volts is present at the junction of the emitter of Q4 (Q6) and the collector of Q3 (Q5). This voltage is applied, through a voltage divider and low-pass filter, to one input of amplifier IC5. When Q4 (Q6) is off and Q3 (Q5) is on, the voltage at the junction of the switches is zero because Q3 (Q5) acts as a short circuit to ground. The DC average level that is developed from the pulse levels of +6.2 volts and 0 volts is proportional to the fraction of the ramp cycle during which Q4 (Q6) remains on. It was previously explained that the ramp period and maximum amplitude of the ramp are directly proportional to the span of the B input signal and Q4 (Q6) is on only when the ramp amplitude is less than that of the span of the A input signal. Thus, the DC average level that is ultimately produced at the input to IC5 is proportional to the quotient of the span of the A input signal divided by the span of the B input signal. Because the time constant of the low-pass filter at the input to IC5 is small compared with the ramp period, the DC level at this point is used as the collector voltage for shunt switch Q3 (Q5).

#### 4.11 AMPLIFIER CIRCUITS DESCRIPTION

*General:* The rectangular wave at the junction of the switches is applied to the low-pass filter between one input terminal of the amplifier and ground. From these pulses, the filter produces a DC average signal that is applied to this input terminal. The ZERO adjust circuit, which operates from the -V1 voltage, applies an adjustable

## MAINTENANCE

### 5.1 INTRODUCTION AND GENERAL INFORMATION

This section contains information to aid in the maintenance of the unit. This includes disassembly instructions for all mechanical options, as well as general troubleshooting. Precautions and special techniques required to replace components are also described.

### 5.2 DISASSEMBLY

When unit troubleshooting is required, it is first necessary to disassemble the unit. The physical configuration of the unit determines the steps to be followed in disassembly. These are described in the following paragraphs.

#### NOTE

Always identify wires — usually by tagging — before disconnecting existing connections.

#### CAUTION

DISCONNECT INPUT SIGNAL AND REMOVE POWER INPUT BEFORE DISASSEMBLING UNIT.

#### 5.2.1 Disassembly of Standard Unit and Units With AB or CP Options

To disassemble a standard, AB, or CP unit, remove the unit from its installed position. If the mounting bracket is used, separate it from the unit by removing the two countersunk screws at the rear of the unit. After the unit has been removed from its installed position, disassemble the unit as follows to gain access to the circuit board.

- a. Remove the two front Phillips-head screws at the top of the unit.
- b. Remove the four Phillips-head screws at the bottom of the unit.
- c. Slide the front panel (with the circuit board still attached) down and free of the sides of the case. Points on the circuit board may now be reached for troubleshooting. It is suggested that the case be used as a container for storing the removed hardware.

#### 5.2.2 Disassembly of Unit in NEMA Boxes

Normally electrical connections are made to NEMA boxes through conduits. Units are secured on a mounting plate in the NEMA boxes. The following disassembly instructions apply to the various configurations.

*Disassembly of Units in OT, WT and FG Enclosures.* Use the following procedures to disassemble unit:

- a. Loosen clamps that hold hinged cover on OT and WT enclosures only, and open enclosure; otherwise loosen screws securing FG cover. Inspect FG gasket for damage and replace if necessary.
- b. Loosen four screws that secure cover on box.
- c. Remove plastic safety cover from unit.
- d. Tag and disconnect wires from unit. On FG units, tag and disconnect ground wire from conduit to mounting post.
- e. Remove four nuts that secure mounting plate assembly into box.
- f. Remove mounting plate assembly from NEMA box.
- g. Loosen and remove mounting nuts that hold units on mounting plate and remove units.
- h. Disassemble unit as described in paragraph 5.2.1.

*Disassembly of Units in FG Enclosure.* Use the following procedures to disassemble unit:

- a. Open cover on box.
- b. Remove plastic safety cover from unit.
- c. Tag and disconnect wires from unit.
- d. Loosen four mounting screws that hold into box.
- e. Remove four nuts that secure unit mounting bracket assembly to rear of box.
- f. Remove units with attached brackets.
- g. Disassemble units from mounting brackets.
- h. Disassemble unit as described in paragraph 5.2.1.

### 5.2.3 Disassembly of Units in PA or PST Enclosures

Use the following procedure to disassemble unit:

- a. Remove unit from terminal block by rocking it slightly while pulling upward.
- b. Remove two nuts, screws, washers, holding front panel to bottom PC board (two front bottom).
- c. Remove two side screws from front panel.
- d. Remove one countersunk screw from back-bottom of unit in bottom of PC board.

Terminal block and card connector are keyed to eliminate error when the unit is reinstalled.

### 5.2.4 Disassembly of Units in EX Enclosures

Use the following procedure to disassemble unit:

- a. Using a bar wrench, attach to wrench lugs and loosen the housing cover from the base.
- b. Unscrew protective cover to expose unit.
- c. Use procedure of paragraph 5.2.3.

### 5.2.5 Disassembly of PM Units

Use the following procedure to disassemble unit. Refer to Figure 5-1 for parts nomenclature.

- a. Pull out safety cover to expose wiring.
- b. Tag and disconnect wires from terminal strip. If troubleshooting requires access to reverse side of PC board, perform the procedure described in next step.
- c. Remove screws holding cover to frame and lift cover off the case assembly.

#### CAUTION

WIRE SERVICE LOOP IS SUFFICIENT TO ALLOW PC BOARD AND END PLATE ASSEMBLIES TO BE TURNED OVER. ANY EXCESSIVE MOVEMENT OF THIS ASSEMBLY MAY CAUSE WIRING DAMAGE.

- d. Remove two nuts and washers that secure PC board and end plate into frame and carefully lift and slide board and plate towards terminal panel, out of end holder.

### 5.2.6 Disassembly of a Plug-In Unit

To remove the cover of a plug-in unit, proceed as follows:

#### CAUTION

DO NOT LIFT FRONT OF COVER MORE THAN ¼ INCH. EXCESSIVE FORCE APPLIED TO COVER MAY BREAK REAR RETAINING CLIPS.

- a. Gently spread forward locking feet and lift front of cover.
- b. With the front of the cover raised, slide the cover to the rear to disengage it from the plug-in card.

To test a plug-in unit in the operating position, a circuit board extender card (M.I.I. Part No. 350-513-00 or equivalent) is required. The extender card brings the unit forward so components on circuit board are accessible for troubleshooting.

### 5.2.7 Disassembly of Plug-In Units in Card Racks

Except for SMR, access to units in racks is effected by removing dust cover over plug-in units. Surface Mounted Racks (SMR) do not have a cover over plug-in units since the whole rack may be enclosed into a NEMA box.

## 5.3 TROUBLESHOOTING

The schematic diagrams include flagged numbers (or letters) at various points in the circuit. Table 5-1 gives the voltages and waveforms at these points for specified input-signal conditions. The assembly drawing shows the physical locations of the parts on the circuit board. Bear in mind that the circuit board is protected with a moisture-resistant coating. Therefore, it may be necessary to use a needle-point probe and exert a fair amount of pressure to break through the coating when it is desired to observe the signal or voltage at a specific point. When connecting a probe to a component on the circuit board, exercise care to make sure the probe does not short-circuit to an adjacent component.

In general, troubleshooting is carried out by tracing the signal with an oscilloscope and referring to the schematic diagrams to determine what component might be causing an observed abnormal indication. If the original symptom was a complete failure of the unit to operate, the most logical components to suspect are those associated with the power supply in the unit (including any voltage regulators). If the unit was producing an incorrect (but not zero) output, check the outputs from the voltage regulator and, if these are normal, apply a standard input signal and trace the resulting signal through the unit.

### 5.3.1 Plug-In Board Connector Cleaning

Occasionally, modules which have been in service for a long period of time may develop resistive coatings on the gold-plated contacts of the plug-in boards. This coating, if allowed to build up, can cause malfunctions by decreasing the noise margin of a circuit.

There are two types of foreign material coatings which can develop on the gold-plated contacts of a plug-in module. The first type is INORGANIC. This type of contamination results when copper "bleeds" through the gold plating and oxidizes. The second form of contamination involves ORGANIC substances, which usually are a result of careless handling, and are mainly made up of fingerprints, salts, and oils deposited when the plug-in boards are handled by the gold-plated contacts. Contamination by organic substances can be greatly reduced by careful handling of the modules.

Although rack connectors are usually of the self-cleaning type, it may become necessary to clean the module fingers to ensure reliable connection. When module contacts are in need of cleaning, the following procedures are recommended:

#### *Removal of Inorganic Contaminants*

- a. Immerse contacts of plug-in board in an ultrasonic bath of deionized water and a detergent, such as Liquinix, for at least 30 seconds.
- b. Repeat step (a) with pure deionized water only.

#### **CAUTION**

REMOVE WATER IMMEDIATELY FROM CONTACTS. IF THIS IS NOT DONE QUICKLY, DAMAGE TO CONTACTS MAY RESULT.

- c. Remove water by immersing contacts in an ethane or methanol bath to same depth used during the ultrasonic cleaning of step (a). Never wipe or use an abrasive cleaner on the contacts. If wiping is necessary, use K-Dry towels or equivalent.

#### *Removal of Organic Contaminants*

- a. After inorganic contaminants and water have been removed, organic materials may be removed by immersion of contacts in trichloroethane for at least 30 seconds.

#### **CAUTION**

NEVER USE AN ERASER ON THE CONTACTS. THE USE OF ABRASIVE CLEANERS OR ERASERS ON PLUG-IN BOARD CONTACTS IS CONSIDERED A PHYSICAL ABUSE TO THE PLUG-IN UNIT AND MAY VOID THE UNIT WARRANTY.

- b. Let contacts air dry or wipe with a very fine, nonabrasive material such as K-Dry towels or equivalent.

### 5.3.2 Component Replacement General Information

Replace all defective components with identical parts. Refer to Section 6 for a list of recommended replacement parts. The last row of numbers in the parts list is the number of spares recommended to be kept on hand for that part, per unit, for up to ten units of the same type. For more than ten units, a spares complement of 10% on the indicated parts should be used.

### 5.3.3 Component Replacement Techniques

Most parts used in the unit are quite small and are located in a confined area. Therefore, small hand tools are a necessity when servicing the unit. The following is a summary of the general techniques and precautions that should be observed to prevent damage to components in the unit:

#### **CAUTION**

CMOS INTEGRATED CIRCUITS ARE VERY SUSCEPTIBLE TO STATIC ELECTRICITY. WHEN REPLACING THESE COMPONENTS, DO NOT HANDLE LEADS BEFORE SOLDERING INTO BOARD. ENSURE THAT SOLDERING IRON IS GROUNDED. SOLDER INTEGRATED CIRCUITS LEAD V (POWER INPUT) BEFORE SOLDERING G (GROUND CONNECTION). FAILURE TO TAKE THESE PRECAUTIONS WILL DAMAGE COMPONENTS.

- a. Use a transformer-operated low-voltage soldering iron with a grounded tip and rated at not more than 50 watts. A temperature-controlled tip is desirable.
- b. Use extreme care when unsoldering the leads to any component. Do not keep the soldering iron on a point for more than a few seconds at a time. Use a suction-type solder-removing tool (solder sucker) as an aid in unsoldering transistors and integrated circuits. The protective coating on the unit may be removed with trichlorethane or equivalent. Be sure adequate ventilation is provided when using this or any other chemical.

#### NOTE

Unused connections on integrated circuits are left unsoldered to aid in removal. Refer to the assembly drawing for more complete information.

- c. Do not excessively bend or twist the leads of small components; they break easily.
- d. Before removing a component, observe the lead dress. Be sure that the lead dress of the replacement is the same as that of the original.
- e. Handle MOSFETs only by the case; if the fingers are allowed to contact the leads, the

MOSFET may be ruined. Be sure to leave the metal sleeve around the leads until just before the device is installed on the printed circuit board.

- f. Remove all flux from soldered joints with trichlorethane or equivalent.

#### NOTE

Units that were calibrated at the factory to customer's specifications have protective caps over the SPAN and ZERO potentiometers. These caps must be removed so the unit can be recalibrated. LIFT, DO NOT TWIST, the caps off, using a screwdriver tip as a prying tool. Snap the caps back in place, WITHOUT TWISTING, when recalibration has been completed.

- g. Test the unit for proper operation and, if necessary, recalibrate by the procedure given in Section 2.
- h. Check that all leads are clear of the board edge before reinstalling the board into its case.
- i. When reinstalling the unit onto the mounting bracket, be sure to use the same screws (or screws of the same size) as the ones removed. Longer screws will damage the unit.

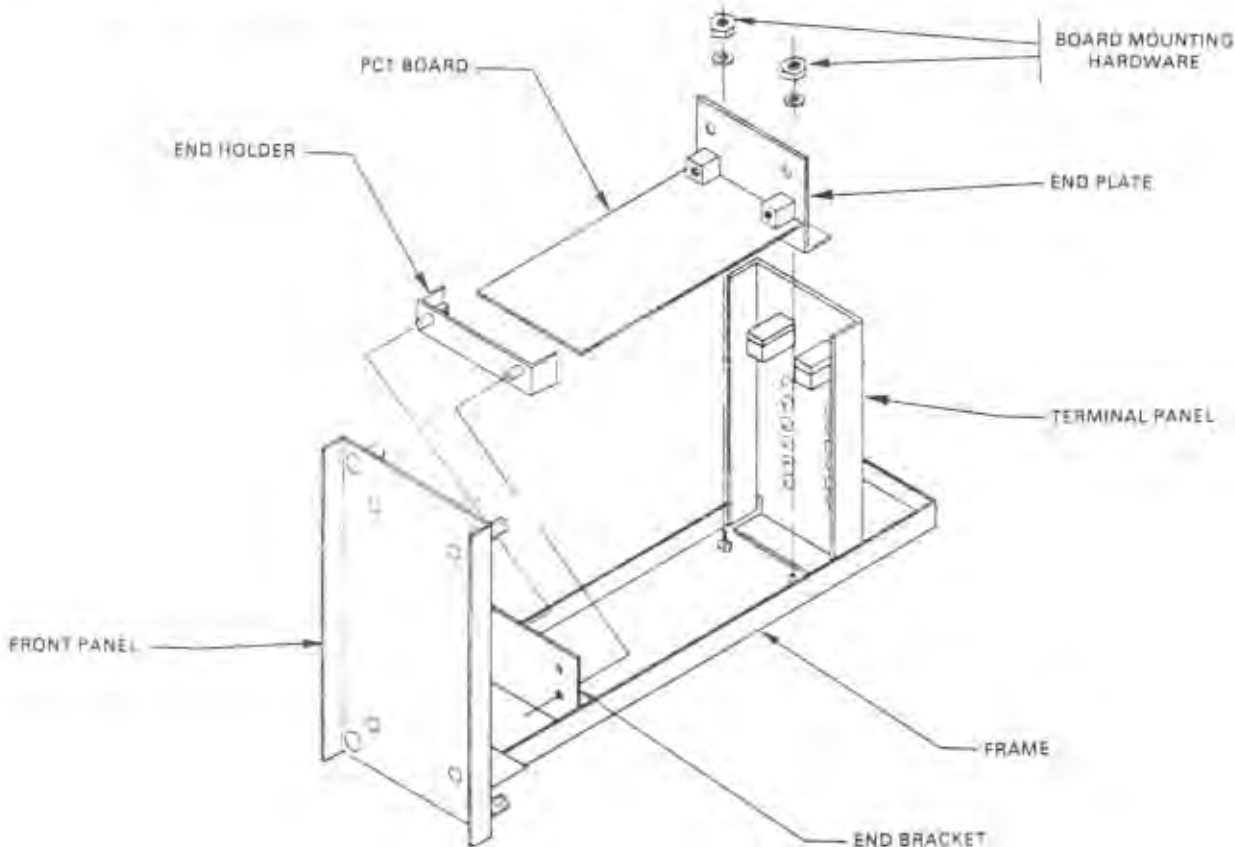
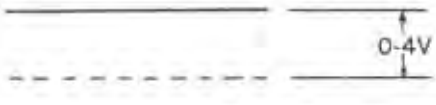

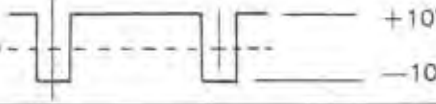
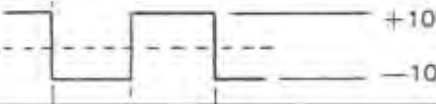

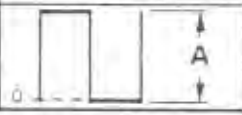

Figure 5-1. Disassembly of PM Units



TABLE 5-1. WAVE FORMS AND VOLTAGES

TEST POINT(S)	WAVE FORM AND AMPLITUDE OR VOLTAGE LEVEL
1	
2	
3	
4	
5	
6	

TEST POINT	WAVEFORM	POWER INPUT AND WAVEFORM AMPLITUDE	
		24VDC/117VAC 220VAC/240VAC	45VDC
9		48V	90V

$\approx 333\mu s$

## 6.1 GENERAL

This section consists of a computer print-out table that provides parts identification information for the unit. Wiring lists have been provided in this section as an aid to the maintenance personnel.

Parts information is grouped according to the number of assemblies. If the unit contains two PC boards, the table will be divided into two major sections: one section will contain information related to PC1 and the other section will list PC2 components information. Each major section in the table contains a complete parts list headed LIST OF MATERIALS specifying which PC board it is describing. This list is usually found at the end of the section. The list of materials consists of the following headings:

*ITEM:* A reference numeral used for data processing and not used by maintenance personnel.

*NAME:* Gives the nomenclature of the part.

*DESCRIPTION:* Identifies the component by manufacturer's part number, usually followed by component's parameters or value.

*REF:* Lists the reference designation for the components described in Section 4 and illustrated in the schematics and assembly drawings.

*PART NUMBER:* This column specifies the Moore Industries assigned part number. This is the part identification required when ordering parts from Moore Industries.

*SPARE:* The numeral in this column specifies the recommended number of component spares per unit type that should be kept on hand by maintenance personnel.

## 6.2 GLOSSARY OF ABBREVIATIONS

C	Capacitor	T	Transformer
CR	Diode — Zener included	IC	Integrated circuit
HW	Special hardware	Q	Transistor
J	Connecting buss wire	LED	Light emitting diode
L	Inductor	TB	Terminal block
LB	Label	VS	Voltage regulating varistor
PC	Printed circuit board	VR	Voltage Regulator
R	Resistor		



REV.	DESCRIPTION	DATE	BY	APPROV.
S	ECO # 6219	7/1/66	AW	[Signature]

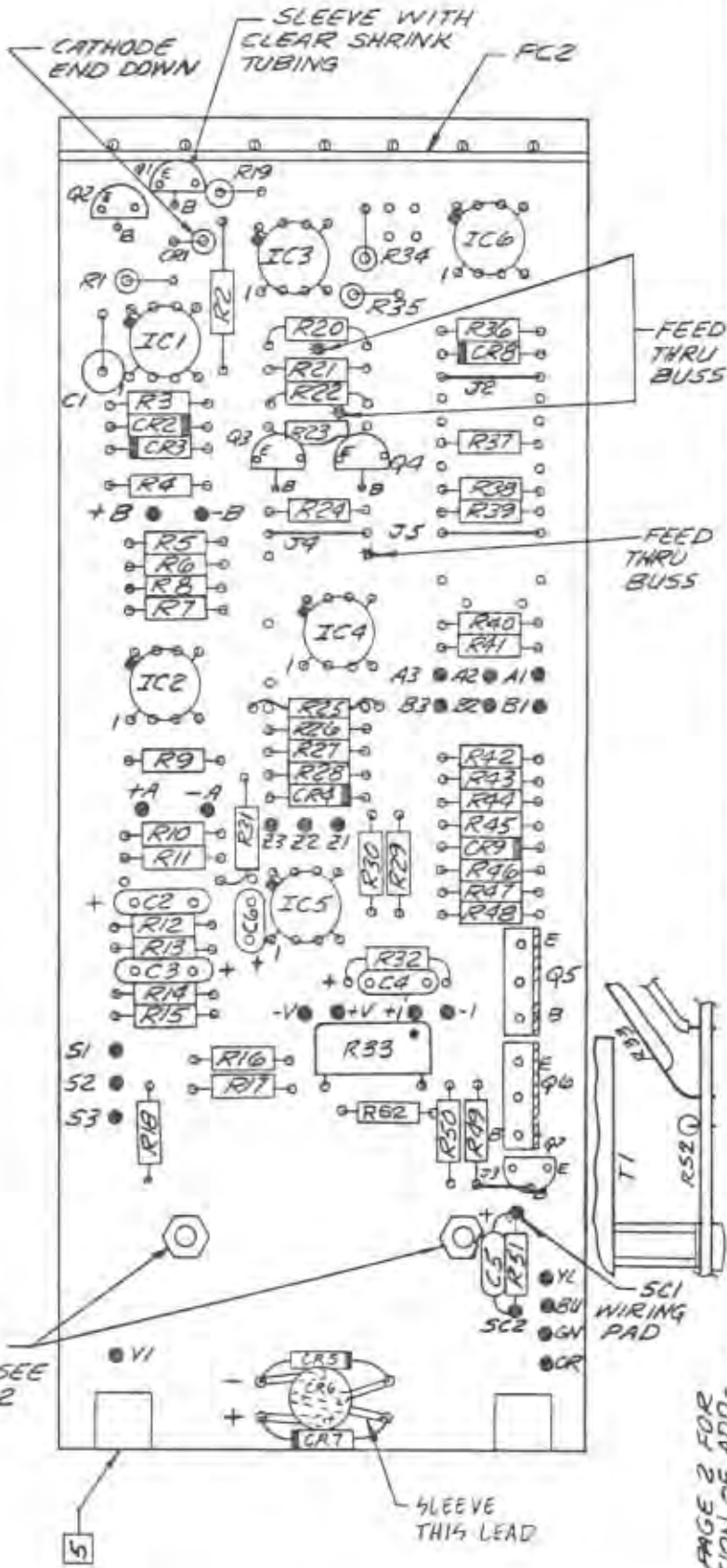

REFERENCE DESIGNATION		MANUFACTURER		PART NAME		LIST OF MATERIALS	
MOORE INDUSTRIES INC. VAN NUYS • CALIF.		ASSEMBLY STANDARD ADB PCI		DO NOT SCALE DRAWING		SCALE 2:1	
196-501-005 PAGE 1 OF 2		JOB NO. 196		FINISH		CUTS	
TOTAL UNLESS NOTED		DRAWN		CHECK		PROJ. # 4877	
QTY		DATE		DATE		DATE	
REV. 1 - 2.016		REV. 1 - 2.016		REV. 1 - 2.016		REV. 1 - 2.016	
ANGLE 1 - 30°		ANGLE 1 - 30°		ANGLE 1 - 30°		ANGLE 1 - 30°	
FINISH		FINISH		FINISH		FINISH	
ADDRESS		ADDRESS		ADDRESS		ADDRESS	
DATE		DATE		DATE		DATE	

1. ALL LEADS MUST BE SOLDERED TO BOARD.
  2. ALL JUMPERS 22 AVG BUSS, TEFLON SLEEVED AS REQUIRED.
  3. FOR MOUNTING OF SWAGE BLOCKS - SEE CASE ASSEMBLY ON TRAVELER.
  4. DIMENSIONS INDICATES METRILIZED SIDE OF Q5 AND Q6.
  5. SEE PAGE 2 FOR LOCATION OF ADDITIONAL COMPONENTS.
- NOTES: UNLESS OTHERWISE SPECIFIED

REV	DESCRIPTION	DATE	BY	APPROV
-----	-------------	------	----	--------

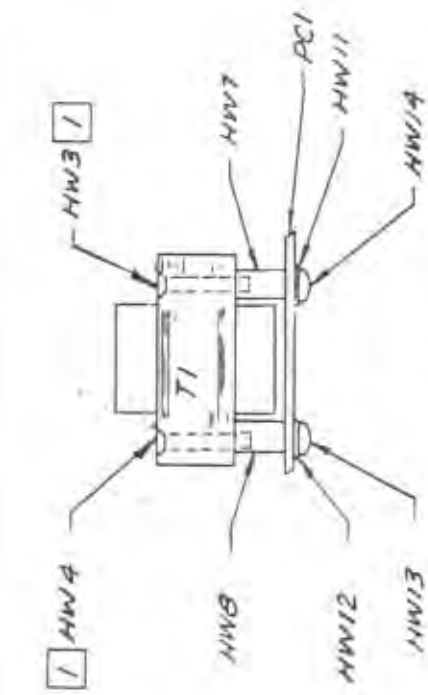

T1 MOUNTING

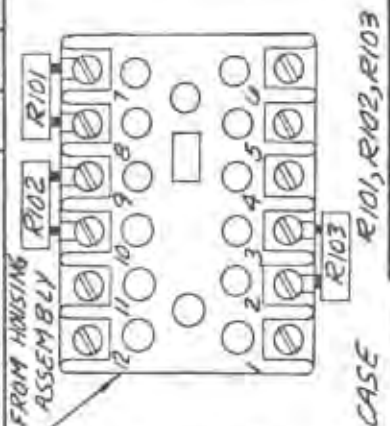
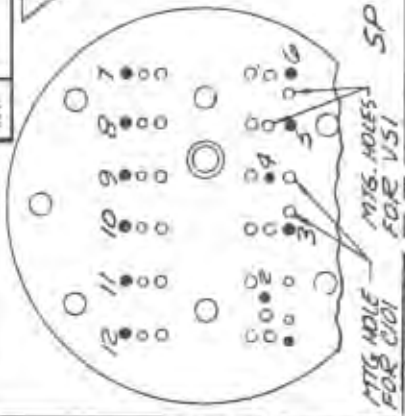

SP CASE

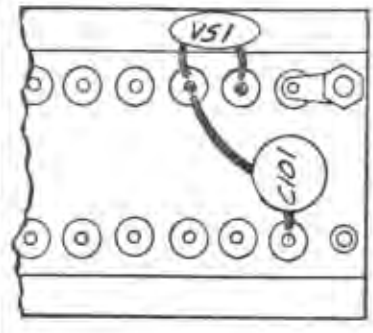
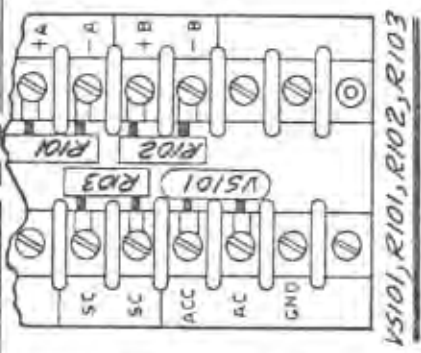

SR & CH CASE

REAR OF PANEL

ITEM	PART NUMBER	PART NAME	MANUFACTURER	REFERENCE DESIGNATION
1		ASSEMBLY STANDARD		
LIST OF MATERIALS				
1		ASSEMBLY STANDARD		
2		ASSEMBLY STANDARD		
3		ASSEMBLY STANDARD		
4		ASSEMBLY STANDARD		
5		ASSEMBLY STANDARD		
6		ASSEMBLY STANDARD		
7		ASSEMBLY STANDARD		
8		ASSEMBLY STANDARD		
9		ASSEMBLY STANDARD		
10		ASSEMBLY STANDARD		
11		ASSEMBLY STANDARD		
12		ASSEMBLY STANDARD		
SCALE 2:1				
JOB NO. 196				
DO NOT SCALE DRAWING				
196-501-005				
SHEET 2 OF 2				



1 INSTALL WITH LOCKWITE ON THREADS.  
 NOTES: UNLESS OTHERWISE SPECIFIED



**MOORE INDUSTRIES**  
18850 Schoenborn Street  
Sepulveda, California 91343

DO NOT SCALE DRAWING	
TOLERANCES UNLESS NOTED	DATE 11/14/77
X ±.1	DESIGNED BY S. JESSOP
XX ±.03	CHECKED BY [Signature]
XXX ±.010	DATE 11/19/78
ANGLES ±30°	SCALE 2/1

# POWER SUPPLY REGULATOR

QUANTITY	196-502-00B
DESCRIPTION	ASSEMBLY
ISSUED BY	ECO 3265
DATE	6/14/78
BY	D
CHKD BY	JHW

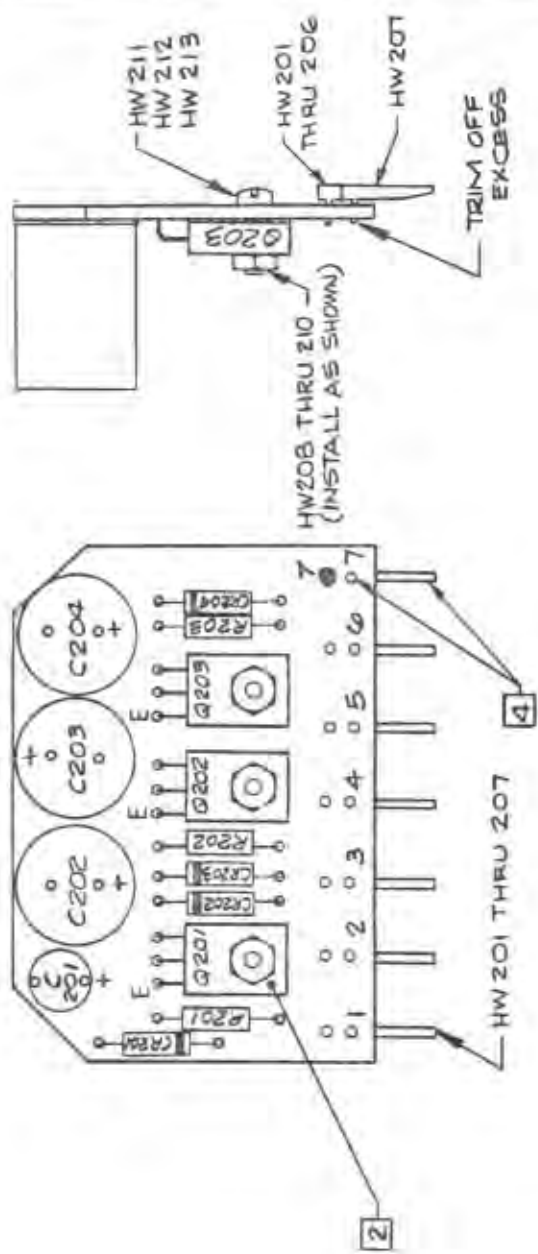

- 4 CUT HW207 BETWEEN TWO UPPER SOLDER PINS & REMOVE UPPER PORTION PRIOR TO INSERTING & SOLDERING IN BOTTOM HOLE. KEEP TOP HOLE FREE OF SOLDER.
- 3. FOR SCHEMATIC SEE DRAWING 196-401-00.
- 2 METAL SIDE OF Q201, Q202 & Q203 TO FACE UP; (AWAY FROM BOARD).

1. ALL LEADS MUST BE SOLDERED TO PADS.

NOTES: UNLESS OTHERWISE SPECIFIED







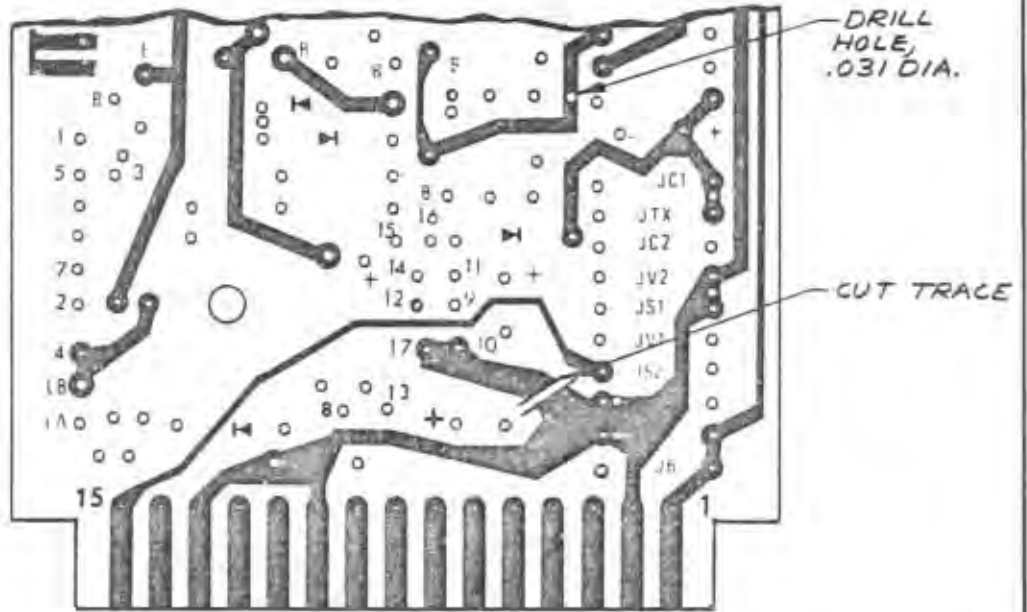

FRONT SIDE

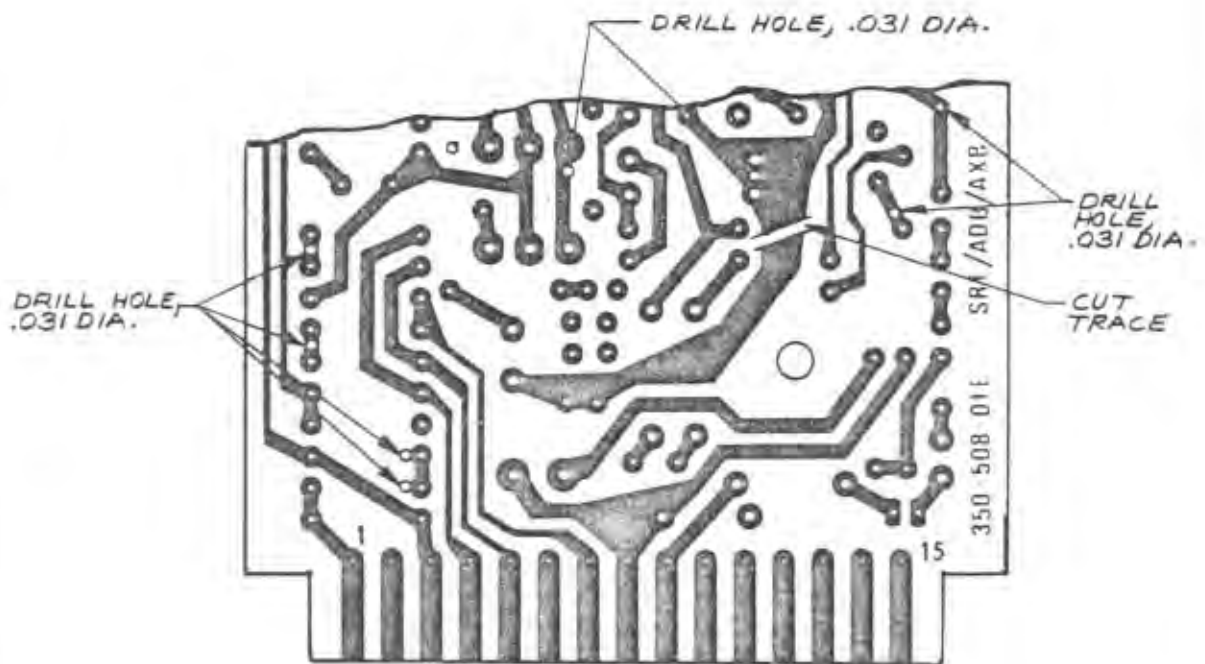

REAR SIDE

## RETURN PROCEDURES

To return equipment to Moore Industries for repair, follow these four steps:

1. Call Moore Industries and request a Returned Material Authorization (RMA) number.

### Warranty Repair –

If you are unsure if your unit is still under warranty, we can use the unit's serial number to verify the warranty status for you over the phone. Be sure to include the RMA number on all documentation.

### Non-Warranty Repair –

If your unit is out of warranty, be prepared to give us a Purchase Order number when you call. In most cases, we will be able to quote you the repair costs at that time. The repair price you are quoted will be a "Not To Exceed" price, which means that the actual repair costs may be less than the quote. Be sure to include the RMA number on all documentation.

2. Provide us with the following documentation:
  - a) A note listing the symptoms that indicate the unit needs repair
  - b) Complete shipping information for return of the equipment after repair
  - c) The name and phone number of the person to contact if questions arise at the factory
3. Use sufficient packing material and carefully pack the equipment in a sturdy shipping container.
4. Ship the equipment to the Moore Industries location nearest you.

The returned equipment will be inspected and tested at the factory. A Moore Industries representative will contact the person designated on your documentation if more information is needed. The repaired equipment, or its replacement, will be returned to you in accordance with the shipping instructions furnished in your documentation.

### WARRANTY DISCLAIMER

THE COMPANY MAKES NO EXPRESS, IMPLIED OR STATUTORY WARRANTIES (INCLUDING ANY WARRANTY OF MERCHANTABILITY OR OF FITNESS FOR A PARTICULAR PURPOSE) WITH RESPECT TO ANY GOODS OR SERVICES SOLD BY THE COMPANY. THE COMPANY DISCLAIMS ALL WARRANTIES ARISING FROM ANY COURSE OF DEALING OR TRADE USAGE, AND ANY BUYER OF GOODS OR SERVICES FROM THE COMPANY ACKNOWLEDGES THAT THERE ARE NO WARRANTIES IMPLIED BY CUSTOM OR USAGE IN THE TRADE OF THE BUYER AND OF THE COMPANY, AND THAT ANY PRIOR DEALINGS OF THE BUYER WITH THE COMPANY DO NOT IMPLY THAT THE COMPANY WARRANTS THE GOODS OR SERVICES IN ANY WAY.

ANY BUYER OF GOODS OR SERVICES FROM THE COMPANY AGREES WITH THE COMPANY THAT THE SOLE AND EXCLUSIVE REMEDIES FOR BREACH OF ANY WARRANTY CONCERNING THE GOODS OR SERVICES SHALL BE FOR THE COMPANY, AT ITS OPTION, TO REPAIR OR REPLACE THE GOODS OR SERVICES OR REFUND THE PURCHASE PRICE. THE COMPANY SHALL IN NO EVENT BE LIABLE FOR ANY CONSEQUENTIAL OR INCIDENTAL DAMAGES EVEN IF THE COMPANY FAILS IN ANY ATTEMPT TO REMEDY DEFECTS IN THE GOODS OR SERVICES, BUT IN SUCH CASE THE BUYER SHALL BE ENTITLED TO NO MORE THAN A REFUND OF ALL MONIES PAID TO THE COMPANY BY THE BUYER FOR PURCHASE OF THE GOODS OR SERVICES.

ANY CAUSE OF ACTION FOR BREACH OF ANY WARRANTY BY THE COMPANY SHALL BE BARRED UNLESS THE COMPANY RECEIVES FROM THE BUYER A WRITTEN NOTICE OF THE ALLEGED DEFECT OR BREACH WITHIN TEN DAYS FROM THE EARLIEST DATE ON WHICH THE BUYER COULD REASONABLY HAVE DISCOVERED THE ALLEGED DEFECT OR BREACH, AND NO ACTION FOR THE BREACH OF ANY WARRANTY SHALL BE COMMENCED BY THE BUYER ANY LATER THAN TWELVE MONTHS FROM THE EARLIEST DATE ON WHICH THE BUYER COULD REASONABLY HAVE DISCOVERED THE ALLEGED DEFECT OR BREACH.

### RETURN POLICY

For a period of thirty-six (36) months from the date of shipment, and under normal conditions of use and service, Moore Industries ("The Company") will at its option replace, repair or refund the purchase price for any of its manufactured products found, upon return to the Company (transportation charges prepaid and otherwise in accordance with the return procedures established by The Company), to be defective in material or workmanship. This policy extends to the original Buyer only and not to Buyer's customers or the users of Buyer's products, unless Buyer is an engineering contractor in which case the policy shall extend to Buyer's immediate customer only. This policy shall not apply if the product has been subject to alteration, misuse, accident, neglect or improper application, installation, or operation. THE COMPANY SHALL IN NO EVENT BE LIABLE FOR ANY INCIDENTAL OR CONSEQUENTIAL DAMAGES.



WORLDWIDE • [www.miinet.com](http://www.miinet.com)

United States • [info@miinet.com](mailto:info@miinet.com)  
Tel: (818) 894-7111 • FAX: (818) 891-2815  
Australia • [sales@mooreind.com.au](mailto:sales@mooreind.com.au)  
Tel: (02) 8536-7200 • FAX: (02) 9525-7296

Belgium • [info@mooreind.be](mailto:info@mooreind.be)  
Tel: 03/448.10.18 • FAX: 03/440.17.97  
The Netherlands • [sales@mooreind.nl](mailto:sales@mooreind.nl)  
Tel: (0)344-617971 • FAX: (0)344-615920

China • [sales@mooreind.sh.cn](mailto:sales@mooreind.sh.cn)  
Tel: 86-21-62491499 • FAX: 86-21-62490635  
United Kingdom • [sales@mooreind.com](mailto:sales@mooreind.com)  
Tel: 01293 514488 • FAX: 01293 536852